

NEW Sectional Garage Door Range



Series 2000 Garage Door Price List

14.7.2014





HÖRMANN IS ALWAYS COMMITTED TO EXCELLENCE: “In Engineering, in User Safety and in Design.”

All our products are third party tested to the highest standards and are certified to the high safety requirements and performance characteristics of the European Standard 13241-1.

This gives you the reassurance that your purchase of a Hörmann product is a safe investment. We are also committed to our national network of Garage Door Specialist Distributors.

These are independent businesses, who believe in customer service and have skills to advise you on the best product for your property, also providing quality fitting and finishing.

“A great product performs at its best when fitted by experts.”

Door Operating Systems

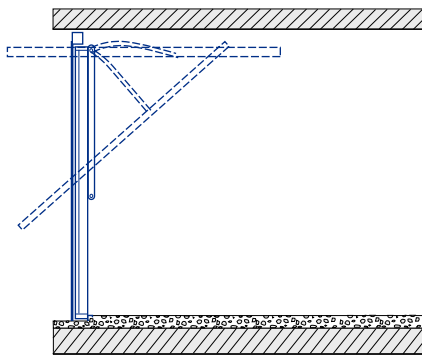

Canopy Operating Gear

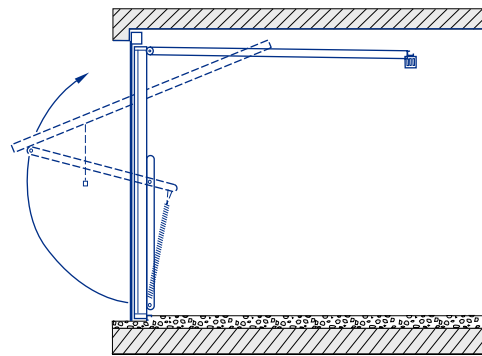

Retractable Operating Gear

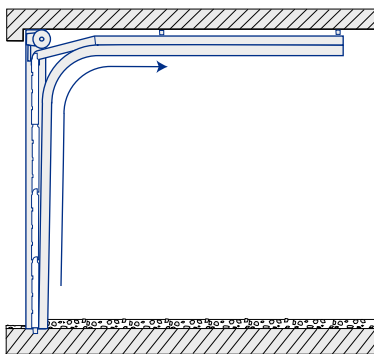



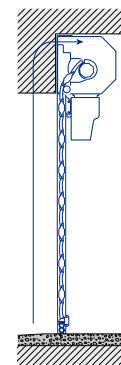







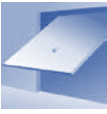



Sectional Operating Gear



RollMatic Operating Gear

We reserve the right to change specification without prior notification.



Contents

	Up-and-over garage doors	Canopy and retractable with steel infill	4
		Canopy and retractable with timber infill	8
		Canopy and retractable with GRP infill (Glass reinforced polyester)	12
	Sectional garage doors	Sectional Garage Doors LTE 40 Single-skinned steel Sectional doors	14
		Sectional Garage Doors LPU 40 Double-skinned steel Sectional doors	15
		Optional extras and window designs	18
		 Sandgrain surface finish	15
		 Titan Metallic CH 703 and Decograin surface Winchester Oak	16
	Double-leaf insulated doors	Double-leaf insulated doors with block frames made of aluminium profiles	19
		 Titan Metallic CH 703 and Decograin surface Winchester Oak	19
	RollMatic roller garage doors	RollMatic Roller Garage Doors	20
		 Decopaint surface Golden Oak or Rosewood	20
	Garage door operators	Garage door operators	23
		Operator accessories	23
		 HS 5 BS hand transmitters in textured plastic surface	23
		 HSE 1 BS hand transmitters in high gloss plastic surface	24
		 HSE 2 BS hand transmitters in textured plastic surface	25
		 HSE 2 BS hand transmitters in textured plastic surface with plastic caps	25
		 Lighting technology	28
 BiSecur LAN / WAN Gateway	29		

Hörmann Up-and-Over Doors

Canopy & retractable with steel infill

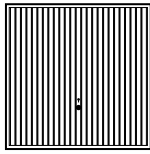
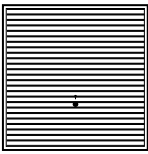
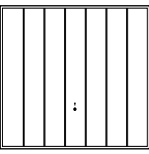
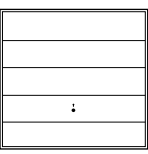

SINGLE DOORS													
Door sizes BR		2001 Vertical		2002 Horizontal		2601 Elegance		2602 Finesse		2101 Ilkley		2103 Caxton	
Imperial	Metric	CAN.	RET.	CAN.	RET.	CAN.	RET.	CAN.	RET.	CAN.	RET.	CAN.	RET.
6'6" x 6'6"	1981 x 1981	535	577	469	511								
7'0"	1981 x 2134	535	577	469	511								
6'10" x 6'4"	2083 x 1930	534	576	481	523								
6'6"	2083 x 1981	534	576	491	533								
7'0"	2083 x 2134	547	589	509	551								
7'0" x 6'4"	2134 x 1930	536 ¹	578 ¹	486	528					897	939		
6'6"	2134 x 1981	521¹	563¹	440¹	482¹	662¹	704¹	662¹	704¹	897	939	865	907
7'0"	2134 x 2134	541¹	583¹	492¹	534¹	700¹	742¹	700¹	742¹	907	949	872	914
7'6"	2134 x 2286		671		627								
7'3" x 6'4"	2210 x 1930	563 ¹	605 ¹	529	571								
6'6"	2210 x 1981	566	608	532	574								
7'0"	2210 x 2134	573	615	538	580								
7'5" x 6'6"	2261 x 1981	570	612	529	571					931	973	917	959
7'0"	2261 x 2134	641	683	604	646					941	983	926	968
7'6" x 6'4"	2286 x 1930	583	625	529	571					931	973		
6'6"	2286 x 1981	583 ¹	625 ¹	529 ¹	571 ¹	735 ¹	777 ¹	735 ¹	777 ¹	931	973	917	959
7'0"	2286 x 2134	641 ¹	683 ¹	606 ¹	648 ¹	848 ¹	890 ¹	848 ¹	890 ¹	941	983	926	968
7'6"	2286 x 2286		730		750								
7'8" x 6'4"	2337 x 1930	661	703	609	651								
8'0" x 6'4"	2438 x 1930	692	734	610	652					988	1030		
6'6"	2438 x 1981	692 ¹	734 ¹	610	652	872	914	872	914	988	1030	949	991
7'0"	2438 x 2134	716 ¹	758 ¹	623	665	907	949	907	949	998	1040	997	1039
7'6"	2438 x 2286		822		731								
8'0"	2438 x 2438		851		761								
8'6" x 6'6"	2590 x 1981		792		703								
7'0"	2590 x 2134		859		728								
9'0" x 6'6"	2743 x 1981		915		876								
7'0"	2743 x 2134		999		919								
10'0" x 6'6"	3048 x 1981		1108		1098								
7'0"	3048 x 2134		1108		1098								

Prices Marked ¹ – optional Terra brown RAL 8028 available. Surcharge on door, see page 7.

DOUBLE DOORS Internal frame sizes BR		2001 Vertical	2002 Horizontal	2601 Elegance	2602 Finesse	2101 Ilkley	Style Not Available
Imperial	Metric	Retractable	Retractable	Retractable	Retractable	Retractable	
11'0" x 6'6"	3353 x 1981	1204 *	1204 *				
7'0"	3353 x 2134	1214 *	1214 *				
12'0" x 6'6"	3658 x 1981	1265 *	1265 *				
7'0"	3658 x 2134	1275 *	1275 *				
13'0" x 6'6"	3962 x 1981	1377 *	1377 *				
7'0"	3962 x 2134	1408 *	1408 *				
14'0" x 6'6"	4267 x 1981	1326	1326			1836*	
7'0"	4267 x 2134	1326	1326			1836*	





Prices Marked * – Not available ex-stock, delivery 2–3 weeks

MATCHING SIDE DOORS Ordering sizes	2001 Vertical	2002 Horizontal	2601 Elegance	2602 Finesse	Style Not Available	Style Not Available
---------------------------------------	------------------	--------------------	------------------	-----------------	------------------------	------------------------

Prices Marked ² – Not available ex-stock, delivery 4–8 weeks

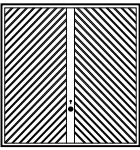
875 x 1875						
875 x 2000	361	730 ²	681 ²	681 ²		
875 x 2125						
1000 x 2000	384	756 ²	777 ²	777 ²		
1000 x 2125						

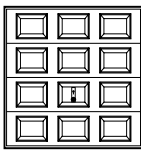

										75mm steel framed doors Recommended structural opening sizes allowing tolerance of 10mm on width & 5mm on height For steel frame options see page 7	
2003 Chevron		2004 Georgian		2304 Georgian with windows		2104 Marquess		2504 Countess		Imperial	Metric
CAN.	RET.	CAN.	RET.	CAN.	RET.	CAN.	RET.	CAN.	RET.		
		653	695							7'0" x 6'8½"	2135 x 2044
		664	706							7'0" x 7'2¾"	2135 x 2199
		661	703							7'4" x 6'6½"	2235 x 1994
		662	704							7'4" x 6'8½"	2235 x 2044
		710	752							7'4" x 7'2¾"	2235 x 2199
		662	704							7'6" x 6'6½"	2284 x 1994
556	598	662 ¹	704 ¹	911	953	662	704	662	704	7'6" x 6'8½"	2284 x 2044
593	635	700 ¹	742 ¹	949	991	700	742	700	742	7'6" x 7'2¾"	2284 x 2199
										7'6" x 7'8½"	2284 x 2350
		735	777							7'9¼" x 6'6½"	2365 x 1994
										7'9¼" x 6'8½"	2365 x 2044
										7'9¼" x 7'2¾"	2365 x 2199
		735	777							7'11" x 6'8½"	2411 x 2044
		848	890							7'11" x 7'2¾"	2411 x 2199
		735	777							8'0" x 6'6½"	2436 x 1994
620	662	735 ¹	777 ¹	984	1026	735	777	735	777	8'0" x 6'8½"	2436 x 2044
682	724	848 ¹	890 ¹	1097	1139	848	890	848	890	8'0" x 7'2¾"	2436 x 2199
										8'0" x 7'8½"	2436 x 2350
		882	924							8'2" x 6'6½"	2489 x 1994
		872	914							8'6" x 6'6½"	2589 x 1994
780	822	872	914			872	914			8'6" x 6'8½"	2589 x 2044
813	855	907	949			907	949			8'6" x 7'2¾"	2589 x 2199
										8'6" x 7'8½"	2589 x 2350
										8'6" x 8'2¾"	2589 x 2503
										9'0" x 6'8½"	2741 x 2044
										9'0" x 7'2¾"	2741 x 2199
			1153							9'6" x 6'8½"	2894 x 2044
			1174							9'6" x 7'2¾"	2894 x 2199
										10'6" x 6'8½"	3199 x 2044
										10'6" x 7'2¾"	3199 x 2199
2003 Chevron		2004 Georgian		2304 Georgian with windows		2104 Marquess		Style Not Available		Imperial	Metric
Retractable		Retractable		Retractable		Retractable					
										11'6" x 6'8½"	3504 x 2044
										11'6" x 7'2¾"	3504 x 2199
										12'6" x 6'8½"	3809 x 2044
										12'6" x 7'2¾"	3809 x 2199
										13'6" x 6'8½"	4114 x 2044
										13'6" x 7'2¾"	4114 x 2199
1742*		1428		1928*		1428*				14'6" x 6'8½"	4419 x 2044
1742*		1428		1928*		1428*				14'6" x 7'2¾"	4419 x 2199
2003 Chevron		2004 Georgian		2304 Georgian with windows		2104 Marquess		Style Not Available			
912 ²		681 ²		786 ²		681 ²					
927 ²		777 ²		882 ²		777 ²					

Hörmann Up-and-Over Doors

Canopy & retractable with steel infill

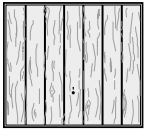
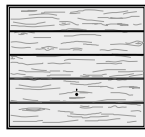
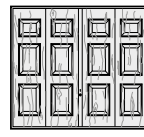
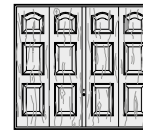
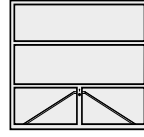

SINGLE DOORS											
Door sizes BR		Vertical Decograin Golden Oak or Rosewood		Horizontal Decograin Golden Oak or Rosewood		Georgian Decograin Golden Oak or Rosewood		Marquess Decograin Golden Oak or Rosewood		2011 Open for infill	
Imperial	Metric	CAN.	RET.	CAN.	RET.	CAN.	RET.	CAN.	RET.	CAN.	RET.
6'6" x 6'6"	1981 x 1981									451	493
7'0"	1981 x 2134									451	493
6'10" x 6'4"	2083 x 1930									451	493
6'6"	2083 x 1981										
7'0"	2083 x 2134										
7'0" x 6'4"	2134 x 1930									451	493
6'6"	2134 x 1981	672	714	597	639	793	835	793	835	451	493
7'0"	2134 x 2134	692	734	647	689	831	873	831	873	481	523
7'6"	2134 x 2286										
7'3" x 6'4"	2210 x 1930									503	545
6'6"	2210 x 1981										
7'0"	2210 x 2134										
7'5" x 6'6"	2261 x 1981	717	759	662	704	885	927	885	927	503	545
7'0"	2261 x 2134	772	814	738	780	1020	1062	1020	1062	518	560
7'6" x 6'4"	2286 x 1930									503	545
6'6"	2286 x 1981	717	759	662	704	882	924	882	924	503	545
7'0"	2286 x 2134	772	814	738	780	1020	1062	1020	1062	517	559
7'6"	2286 x 2286										
7'8" x 6'4"	2337 x 1930									526	568
8'0" x 6'4"	2438 x 1930									526	568
6'6"	2438 x 1981	826	868	731	773	1038	1080	1038	1080	526	568
7'0"	2438 x 2134	851	893	759	801	1074	1116	1074	1116	526	568
7'6"	2438 x 2286										
8'0"	2438 x 2438										
8'6" x 6'6"	2590 x 1981										
7'0"	2590 x 2134										
9'0" x 6'6"	2743 x 1981										626
7'0"	2743 x 2134										636
10'0" x 6'6"	3048 x 1981										1130
7'0"	3048 x 2134										1130
DOUBLE DOORS Internal frame sizes BR		Style Not Available		Style Not Available		Style Not Available		Style Not Available		2011 Open for infill Retractable	
Imperial	Metric										
11'0" x 6'6"	3353 x 1981										1527
7'0"	3353 x 2134										1594
12'0" x 6'6"	3658 x 1981										1616
7'0"	3658 x 2134										1677
13'0" x 6'6"	3962 x 1981										1696
7'0"	3962 x 2134										1750
14'0" x 6'6"	4267 x 1981										1585
7'0"	4267 x 2134										1585
Prices Marked * - Not available ex-stock, delivery 2-3 weeks											
MATCHING SIDE DOORS Ordering sizes		2001 Golden Oak or Rosewood		2002 Golden Oak or Rosewood		2004 Golden Oak or Rosewood		2104 Golden Oak or Rosewood		2011 Open for infill	
Prices Marked ² - Not available ex-stock, delivery 4-8 weeks											
875 x 1875											
875 x 2000		750 ²		750 ²		750 ²		750 ²			361
875 x 2125											
1000 x 2000		861 ²		861 ²		861 ²		861 ²			384
1000 x 2125											



The door leaf and optional box section steel frame are made of galvanised material that is polyester powder coated on both sides.

This finish is extremely durable and the standard colour is Traffic white RAL 9016.

Other colours are available listed in optional extras below.

To help maintain the aesthetic appearance of your door and prevent the build up of dirt, salt and other corrosive substances the door should be washed with a mild soap-based solution on a regular basis.

If the door is located near the coast it is important that the door panel and frame should be washed at least every 2 months.

We also suggest that all other components are brushed down on a regular basis to prevent the build up of dirt and dust etc.

The window frames on the Georgian and Ilkley doors are UPVC and white as standard.

These frames are a 2-part construction with the window material sandwiched between and frames screwed together from the back for security.

The finish of the Decograin doors is a synthetic foil-coated timber design outside (inside primer white).

The leaf frame and fixing frame is a matching powder coating.



For further choice of exciting door designs in steel, traditional or contemporary, with a vast range of sizes and increased range of colours, ask your garage door specialist about the N 80 Up-and-Over garage doors available to special order.

Optional extras for Steel Doors	Price
75mm Steel fixing frame for either canopy or retractable geared single doors. Factory fitted	100
75mm Steel fixing frame for either canopy or retractable geared single doors. Factory fitted with frame to compliment Decograin	100
75mm Steel fixing frame for DOUBLE retractable geared doors, when ordered with the door	158
60mm Steel fixing frame for canopy geared doors only. Factory fitted	103
60mm Steel fixing frame for canopy geared doors only. Factory fitted with frame to compliment Decograin	103
Please note: Factory fitted 8' high frame not available	
Prices marked ¹ – optional Terra Brown RAL 8028 available. Surcharge on door	27
Retractable plus gear for retractable doors up to 7'6" wide giving extra drive through width	
Surcharge on retractable price	51
4 point locking kit for extra security, factory fit with door order or retrofit – single door sizes only	46
3 point locking kit for extra security, factory fit with door (this cannot be retrofitted). Available for 2001 side doors only	92
Window options for 2304 Georgian style door – Plain, crossed or diamond style with crystal glazing	Incl.
Colours are available to special order in the following styles:	
2001 Vertical, 2002 Horizontal, 2101 Ilkley available in all the listed sizes	
2004 Georgian, 2304 Georgian with windows and 2104 Marquess are available in 7066, 7070, 7566, 7570, 7666, 7670 and 8066, 8070 sizes only	
Please note: Caxton, Chevron, Elegance, Finesse and Countess steel up-and-over doors are only available in white	
Colours:	
Terra Brown RAL 8028, Signal Blue RAL 5005, Steel Blue RAL 5011, Moss Green RAL 6005, Ruby Red RAL 3003, Jet Black RAL 9005	
Includes matching frame if ordered with door. White frame RAL 9016 also available, please specify when ordering	
Please allow 3–4 weeks lead time for coloured doors	
	Single doors 95
	Double doors 153
Coloured window frames for Georgian and Ilkley doors:	
Coloured window frames to match door colour	
Georgian doors (price per window, see note below for the number of windows)	28
Ilkley doors (price per single door)	133
Ilkley doors (price per double door)	266
Please state coloured windows required on order	
Orders received without reference will be supplied with white as standard	
Georgian doors up to 10' wide = 4 windows, between 10' to 13' = 6 windows, between 13' to 14' = 8 windows	
Optional handle sets	
Cast Aluminium silver colour and brass colour	109
Cast Aluminium white and brown	131
Brushed or polished stainless steel	158
Matching lever handles are also available for side doors	P.O.A.



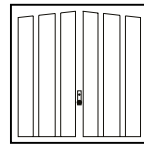
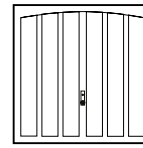
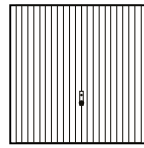

Hörmann Up-and-Over Doors

Canopy & retractable with timber infill

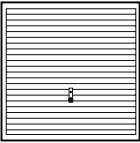

SINGLE DOORS											
Door sizes BR		2005 Measham		2007 Jacobean		2008 Tudor		2014 Rutland		2009 Vertical or Horizontal	
Imperial	Metric	CAN.	RET.	CAN.	RET.	CAN.	RET.	CAN.	RET.	CAN.	RET.
6'6" x 6'6"	1981 x 1981	950	992	1148	1190	1148	1190	1148	1190	1311	1353
7'0"	1981 x 2134	950	992	1148	1190	1148	1190	1148	1190	1311	1353
6'10" x 6'4"	2083 x 1930	950	992	1148	1190	1148	1190	1148	1190	1311	1353
6'6"	2083 x 1981										
7'0"	2083 x 2134										
7'0" x 6'4"	2134 x 1930	950	992	1148	1190	1148	1190	1148	1190	1311	1353
6'6"	2134 x 1981	950	992	1148	1190	1148	1190	1148	1190	1311	1353
7'0"	2134 x 2134	950	992	1148	1190	1148	1190	1148	1190	1311	1353
7'6"	2134 x 2286										
7'3" x 6'4"	2210 x 1930	987	1029	1202	1244	1202	1244	1202	1244	1359	1401
6'6"	2210 x 1981										
7'0"	2210 x 2134										
7'5" x 6'6"	2261 x 1981	987	1029	1202	1244	1202	1244	1202	1244	1359	1401
7'0"	2261 x 2134	1063	1105	1240	1282	1240	1282	1240	1282	1390	1432
7'6" x 6'4"	2286 x 1930	987	1029	1202	1244	1202	1244	1202	1244	1359	1401
6'6"	2286 x 1981	987	1029	1202	1244	1202	1244	1202	1244	1359	1401
7'0"	2286 x 2134	1011	1053	1240	1282	1240	1282	1240	1282	1390	1432
7'6"	2286 x 2286										
8'0"	2286 x 2438										
7'8" x 6'4"	2337 x 1930	1026	1068	1256	1298	1256	1298	1256	1298	1359	1401
8'0" x 6'4"	2438 x 1930	1043	1085	1269	1311	1269	1311	1269	1311	1437	1479
6'6"	2438 x 1981	1043	1085	1269	1311	1269	1311	1269	1311	1437	1479
7'0"	2438 x 2134	1066	1108	1302	1344	1302	1344	1302	1344	1479	1521
8'0"	2438 x 2438										
8'6" x 6'6"	2590 x 1981										
7'0"	2590 x 2134										
9'0" x 6'6"	2743 x 1981		1272		1474		1474		1474		1575
7'0"	2743 x 2134		1272		1474		1474		1474		1575
10'0" x 6'6"	3048 x 1981		1277		1576		1576		1576		1646
7'0"	3048 x 2134		1277		1576		1576		1576		1646
DOUBLE DOORS Internal frame sizes BR		2005 Measham		2007 Jacobean		2008 Tudor		2014 Rutland		2009 Vertical or Horizontal	
Imperial	Metric	CAN.	RET.	CAN.	RET.	CAN.	RET.	CAN.	RET.	CAN.	RET.
11'0" x 6'6"	3353 x 1981		2252		2484		2484		2484		2653
7'0"	3353 x 2134		2252		2484		2484		2484		2653
12'0" x 6'6"	3658 x 1981		2337		2497		2497		2497		2933
7'0"	3658 x 2134		2337		2497		2497		2497		2933
13'0" x 6'6"	3962 x 1981		2346		2694		2694		2694		3280
7'0"	3962 x 2134		2346		2694		2694		2694		3280
14'0" x 6'6"	4267 x 1981		2351		2651		2651		2651		2748
7'0"	4267 x 2134		2351		2651		2651		2651		2748
Please note: Lead times on all timber garage doors will be 3 to 4 weeks											
MATCHING SIDE DOORS Ordering sizes		2005 Measham		2007 Jacobean		2008 Tudor		2014 Rutland		2009 Vertical or Horizontal	
Please note: Lead times on all timber side garage doors will be 4 to 8 weeks											
875 x 1875											
875 x 2000		646		747		747		747		756	
875 x 2125											
1000 x 2000											
1000 x 2125		678		778		778		778		789	



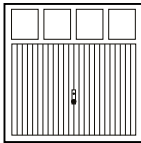



										75mm steel framed doors Recommended structural opening sizes allowing tolerance of 10mm on width & 5mm on height For steel frame options see page 11	
2109 Mallory Horizontal or Vertical		2013 Caxton		2020 Gatcombe		2114 Shepshed		2019 Garage Light		Imperial	Metric
CAN.	RET.	CAN.	RET.	CAN.	RET.	CAN.	RET.	CAN.	RET.		
1308	1350	1519	1561	1519	1561	1519	1561	1570	1612	7'0" x 6'8½"	2135 x 2044
1308	1350	1519	1561	1519	1561	1519	1561	1570	1612	7'0" x 7'2¾"	2135 x 2199
1308	1350	1519	1561	1519	1561	1519	1561	1570	1612	7'4" x 6'6½"	2235 x 1994
										7'4" x 6'8½"	2235 x 2044
										7'4" x 7'2¾"	2235 x 2199
1308	1350	1519	1561	1519	1561	1519	1561	1570	1612	7'6" x 6'6½"	2284 x 1994
1308	1350	1519	1561	1519	1561	1519	1561	1570	1612	7'6" x 6'8½"	2284 x 2044
1308	1350	1519	1561	1519	1561	1519	1561	1570	1612	7'6" x 7'2¾"	2284 x 2199
										7'6" x 7'8½"	2284 x 2350
1359	1401	1568	1610	1568	1610	1568	1610	1639	1681	7'9¼" x 6'6½"	2365 x 1994
										7'9¼" x 6'8½"	2365 x 2044
										7'9¼" x 7'2¾"	2365 x 2199
1359	1401	1568	1610	1568	1610	1568	1610	1639	1681	7'11" x 6'8½"	2411 x 2044
1410	1452	1593	1635	1593	1635	1593	1635	1681	1723	7'11" x 7'2¾"	2411 x 2199
1359	1401	1568	1610	1568	1610	1568	1610	1639	1681	8'0" x 6'6½"	2436 x 1994
1359	1401	1568	1610	1568	1610	1568	1610	1639	1681	8'0" x 6'8½"	2436 x 2044
1410	1452	1593	1635	1593	1635	1593	1635	1715	1757	8'0" x 7'2¾"	2436 x 2199
										8'0" x 7'8½"	2436 x 2350
										8'0" x 8'2¾"	2436 x 2503
1495	1537	1719	1761	1719	1761	1719	1761	1839	1881	8'2" x 6'6½"	2489 x 1994
1495	1537	1719	1761	1719	1761	1719	1761	1839	1881	8'6" x 6'6½"	2589 x 1994
1495	1537	1719	1761	1719	1761	1719	1761	1839	1881	8'6" x 6'8½"	2589 x 2044
1495	1537	1719	1761	1719	1761	1719	1761	1839	1881	8'6" x 7'2¾"	2589 x 2199
										8'6" x 8'2¾"	2589 x 2503
										9'0" x 6'8½"	2741 x 2044
										9'0" x 7'2¾"	2741 x 2199
	1730		1974		1974		1974		2028	9'6" x 6'8½"	2894 x 2044
	1730		1974		1974		1974		2028	9'6" x 7'2¾"	2894 x 2199
	1886		2101		2101		2101		2254	10'6" x 6'8½"	3199 x 2044
	1886		2101		2101		2101		2254	10'6" x 7'2¾"	3199 x 2199
2109 Mallory		2013 Caxton		2020 Gatcombe		2114 Shepshed		2019 Garage Light		Imperial	Metric
CAN.	RET.	CAN.	RET.	CAN.	RET.	CAN.	RET.	CAN.	RET.		
	2792		2948		2948		2948		3282	11'6" x 6'8½"	3504 x 2044
	2792		2948		2948		2948		3282	11'6" x 7'2¾"	3504 x 2199
	3028		3205		3205		3205		3609	12'6" x 6'8½"	3809 x 2044
	3028		3205		3205		3205		3609	12'6" x 7'2¾"	3809 x 2199
	3285		3503		3503		3503		4065	13'6" x 6'8½"	4114 x 2044
	3285		3503		3503		3503		4065	13'6" x 7'2¾"	4114 x 2199
	3191		3407		3407		3407		3852	14'6" x 6'8½"	4419 x 2044
	3191		3407		3407		3407		3852	14'6" x 7'2¾"	4419 x 2199
2109 Mallory		2013 Caxton		2020 Gatcombe		2114 Shepshed		2019 Garage Light			
	852		882		899		877		1004		
	887		916		936		910		1036		

Hörmann Up-and-Over Doors

Canopy & retractable with timber infill

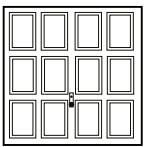

SINGLE DOORS										75mm steel framed doors Recommended structural opening sizes allowing tolerance of 10mm on width & 5mm on height For steel frame options see page 11	
Door sizes BR		2119 Leicester		2010 Chevron		2121 Chesterfield		2122 Middleton		Imperial	Metric
Imperial	Metric	CAN.	RET.	CAN.	RET.	CAN.	RET.	CAN.	RET.		
6'6" x 6'6"	1981 x 1981		1820	1622	1664		2080		2063	7'0" x 6'8½"	2135 x 2044
7'0"	1981 x 2134		1820	1622	1664		2080		2063	7'0" x 7'2¾"	2135 x 2199
6'10" x 6'4"	2083 x 1930		1820	1622	1664		2080		2063	7'4" x 6'6½"	2235 x 1994
6'6"	2083 x 1981									7'4" x 6'8½"	2235 x 2044
7'0"	2083 x 2134									7'4" x 7'2¾"	2235 x 2199
7'0" x 6'4"	2134 x 1930		1834	1622	1664		2080		2063	7'6" x 6'6½"	2284 x 1994
6'6"	2134 x 1981		1834	1622	1664		2080		2063	7'6" x 6'8½"	2284 x 2044
7'0"	2134 x 2134		1834	1622	1664		2094		2086	7'6" x 7'2¾"	2284 x 2199
7'6"	2134 x 2286									7'6" x 7'8½"	2284 x 2350
7'3" x 6'4"	2210 x 1930		2000	1695	1737		2233		2226	7'9¼" x 6'6½"	2365 x 1994
6'6"	2210 x 1981									7'9¼" x 6'8½"	2365 x 2044
7'0"	2210 x 2134									7'9¼" x 7'2¾"	2365 x 2199
7'5" x 6'6"	2261 x 1981		2009	1695	1737		2237		2226	7'11" x 6'8½"	2411 x 2044
7'0"	2261 x 2134		2086	1741	1783		2247		2237	7'11" x 7'2¾"	2411 x 2199
7'6" x 6'4"	2286 x 1930		2007	1695	1737		2237		2226	8'0" x 6'6½"	2436 x 1994
6'6"	2286 x 1981		2007	1695	1737		2237		2226	8'0" x 6'8½"	2436 x 2044
7'0"	2286 x 2134		2086	1741	1783		2259		2247	8'0" x 7'2¾"	2436 x 2199
7'6"	2286 x 2286									8'0" x 7'8½"	2436 x 2350
8'0"	2286 x 2438									8'2" x 6'6½"	2436 x 2503
7'8" x 6'4"	2337 x 1930		2141	1852	1894					8'6" x 6'6½"	2489 x 1994
8'0" x 6'4"	2438 x 1930		2148	1852	1894					8'6" x 6'8½"	2589 x 1994
6'6"	2438 x 1981		2148	1852	1894					8'6" x 7'2¾"	2589 x 2044
7'0"	2438 x 2134		2196	1881	1923					8'6" x 7'8½"	2589 x 2199
8'0"	2438 x 2438									8'6" x 8'2¾"	2589 x 2503
8'6" x 6'6"	2590 x 1981									9'0" x 6'8½"	2741 x 2044
7'0"	2590 x 2134									9'0" x 7'2¾"	2741 x 2199
9'0" x 6'6"	2743 x 1981		2251		2048					9'6" x 6'8½"	2894 x 2044
7'0"	2743 x 2134		2251		2048					9'6" x 7'2¾"	2894 x 2199
10'0" x 6'6"	3048 x 1981		2536		2384					10'6" x 6'8½"	3199 x 2044
7'0"	3048 x 2134		2536		2384					10'6" x 7'2¾"	3199 x 2199
DOUBLE DOORS Internal Frame Sizes BR		2119 Leicester		2010 Chevron		Style Not Available		Style Not Available		Imperial	Metric
BR	RET.	CAN.	RET.	CAN.	RET.	CAN.	RET.	CAN.	RET.		
11'0" x 6'6"	3353 x 1981		3535		3383					11'6" x 6'8½"	3504 x 2044
7'0"	3353 x 2134		3535		3383					11'6" x 7'2¾"	3504 x 2199
12'0" x 6'6"	3658 x 1981		3780		3446					12'6" x 6'8½"	3809 x 2044
7'0"	3658 x 2134		3780		3446					12'6" x 7'2¾"	3809 x 2199
13'0" x 6'6"	3962 x 1981		4137		3503					13'6" x 6'8½"	4114 x 2044
7'0"	3962 x 2134		4137		3503					13'6" x 7'2¾"	4114 x 2199
14'0" x 6'6"	4267 x 1981		4035		3407					14'6" x 6'8½"	4419 x 2044
7'0"	4267 x 2134		4035		3407					14'6" x 7'2¾"	4419 x 2199
Please note: Lead times on all timber garage doors will be 3 to 4 weeks											
MATCHING SIDE DOORS Ordering Sizes		2119 Leicester		2010 Chevron		2121 Chesterfield		2122 Middleton			
Please note: Lead times on all timber side garage doors will be 4 to 8 weeks											
875 x 1875											
875 x 2000			770		747		747		770		
875 x 2125											
1000 x 2000			789		778		778		789		
1000 x 2125											



Our timber garage doors are constructed as an infill to fit into the Open-for-Infill Up-and-Over door frame, this gives the doors their rigid and durable construction.

The styles Measham, Jacobean, Tudor and Rutland are cedar facings glued and fixed to exterior quality plywood.

The solid cedar doors are 12mm tongue and groove boards constructed as an infill.

Cedar is organically grown with natural colour and grain variations; this is a feature of cedar.

We make every effort to harmonise the effect where possible, by hand matching the component parts used in construction.

Please note a uniform overall grain pattern cannot be guaranteed.

Protection (Basecoat)

All our timber doors are supplied with a dip immersion coat of Remmers Induline GW306 base stain primer 006 Light Oak; this coating is for temporary protection only.

If purchased in this temporary finish, please ensure that a full specification of finishing coats are applied immediately before or after installation to all exposed surfaces - inside as well as outside - with a Remmers or similar finishing coat system.

A fully finished option is available, please see options below.

For further choice of exciting door designs, traditional or contemporary in Nordic Pine and Hemlock, with a vast range of sizes, ask your garage door specialist about the N80 Up-and-Over garage doors available to special order.

Optional extras for timber doors	Price	
75mm Steel fixing frame for either canopy or retractable geared single doors, factory fitted Terra brown RAL 8028 as standard	100	
75mm Steel fixing frame for DOUBLE retractable geared doors Terra brown RAL 8028 as standard when ordered with the door	158	
60mm Steel fixing frame for canopy geared doors only, factory fitted Terra brown RAL 8028 as standard	103	
Please note: Factory fitted 8' high frame not available		
Retractable plus gear for retractable doors up to 7'6" wide giving extra drive through width Surcharge on retractable price	51	
4 point locking kit for extra security, factory fit with door order or retrofit	46	
Window options for 2019 Garage Light door - Crystal or clear glazing and can be plain or with square or diamond simulated leading	Incl.	
Over cladding of the OFI chassis (not available in combination with retractable plus)	Single 65	Double 130

Fully finished option

This is available as a factory process giving a 5 year erosion protection

The product used is Remmers and is available in the following stain colours:

Mahogany, Walnut, Dark Oak, Medium Oak, Light Oak, Teak, Ebony, Rosewood and Golden Oak

For south facing situations exposed to strong sunlight, the dark colours are NOT recommended as they can store excessive heat and dry out

	Stain finish	Traffic white RAL 9016	RAL to choose
Door sizes up to 8'0" x 7'0"	107	184	245
Door sizes up to 14'0" x 7'0"	245	332	609
Side Doors	79	166	208

Optional handle sets

Cast Aluminium silver colour and brass colour	109
Cast Aluminium white and brown	131
Brushed or polished stainless steel	158
Matching lever handles are also available for side doors	P.O.A.

Hörmann Up-and-Over Doors

Canopy & retractable with GRP infill

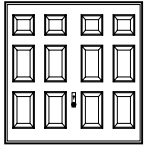
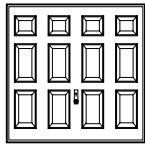
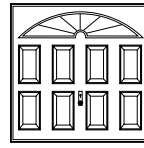
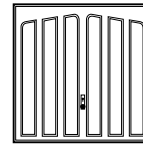
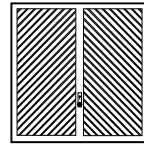

SINGLE DOORS											
Door sizes BR		2042 Windermere		2041 Coniston		2044 Stamford		2034 Penshurst		2035 Hartfield	
Imperial	Metric	CAN.	RET.	CAN.	RET.	CAN.	RET.	CAN.	RET.	CAN.	RET.
7'0" x 6'6"	2134 x 1981	1569	1611	1535	1577	1611	1653	1663	1705	1663	1705
7'0"	2134 x 2134	1569	1611	1535	1577	1611	1653	1663	1705	1663	1705
7'6" x 6'6"	2286 x 1981	1663	1705	1621	1663	1697	1739	1809	1851	1809	1851
7'0"	2286 x 2134	1663	1705	1621	1663	1697	1739	1809	1851	1809	1851
8'0" x 6'6"	2438 x 1981	1789	1831	1769	1811	1837	1879	1926	1968		
7'0"	2438 x 2134	1789	1831	1769	1811	1837	1879	1926	1968		
9'0" x 6'6"	2743 x 1981		2017*		1971*		2035*		2076		
7'0"	2743 x 2134		2017*		1971*		2035*		2076		

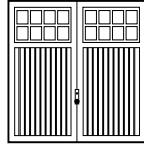
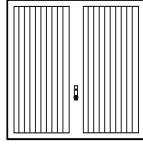
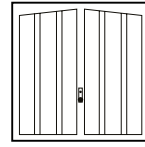
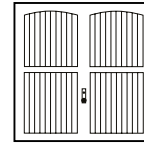
SINGLE DOORS & DOUBLE DOORS									
Door sizes BR		2040 Livingston		2047 Bourton		2048 Burford		2049 Moreton	
Imperial	Metric	CAN.	RET.	CAN.	RET.	CAN.	RET.	CAN.	RET.
7'0" x 6'6"	2134 x 1981	1839	1881	1663	1705	1663	1705	1839	1881
7'0"	2134 x 2134	1839	1881	1663	1705	1663	1705	1839	1881
7'6" x 6'6"	2286 x 1981	1986	2028	1809	1851	1809	1851	1986	2028
7'0"	2286 x 2134	1986	2028	1809	1851	1809	1851	1986	2028
8'0" x 6'6"	2438 x 1981			1926	1968	1926	1968	2101	2143
7'0"	2438 x 2134			1926	1968	1926	1968	2101	2143
14'0" x 6'6"	4267 x 1981				3054		3314		3328
7'0"	4267 x 2134				3054		3314		3328

Coniston and Stamford are supplied in white RAL 9016 OFI, all other styles are supplied in Terra brown RAL 8028 OFI.

75mm steel framed doors

Door sizes BR		Recommended structural opening sizes allowing tolerance of 10mm on width & 5mm on height	
Imperial	Metric	Imperial	Metric
7'0" x 6'6"	2134 x 1981	7'6" x 6'8½"	2284 x 2044
7'0" x 7'0"	2134 x 2134	7'6" x 7'2¾"	2284 x 2199
7'6" x 6'6"	2286 x 1981	8'0" x 6'8½"	2436 x 2044
7'6" x 7'0"	2286 x 2134	8'0" x 7'2¾"	2436 x 2199
8'0" x 6'6"	2438 x 1981	8'6" x 6'8½"	2589 x 2044
8'0" x 7'0"	2438 x 2134	8'6" x 7'2¾"	2589 x 2199
9'0" x 6'6"	2743 x 1981	9'6" x 6'8½"	2894 x 2044
9'0" x 7'0"	2743 x 2134	9'6" x 7'2¾"	2894 x 2199

For GRP colour options please consult main brochure

Window Options	Price
Clear or translucent	Per door 158
Clear or translucent with decorative leading	Per door 263

Windows are available in the Windermere and Coniston (clear or translucent) Stamford comes with black windows as standard

* Doors only available without handle (automation required)

Hörmann Sectional Doors



// NEW Products

// NEW Sandgrain

Sandgrain replaces New Silkgrain – a fine structured coating, available in traffic white and 3 coil coated colours – Anthracite grey RAL 7016, White aluminium RAL 9006, Terra brown RAL 8028

Silkgrain

The original Silkgrain - the premium silk-smooth surface finish re-introduced on LPU 40

// NEW Decograin

New Decograin finishes – Winchester Oak and Titan Metallic CH703 available from Autumn 2014

Decograin timber effect in L-Ribbed style introduced to LPU 40 range

// NEW Double-leaf insulated doors

Double-leaf insulated doors, up to 2500mm wide in a range of ribbed styles and finishes

Door sizes

Large range of standard sizes is supplemented with intermediate widths and heights available by modification at Hörmann's UK headquarters. Please consult with your Hörmann UK's specialist installer.

Secured by design

- LPU40 sectional doors are certified SBD when fitted with a ProMatic or SupraMatic BiSecur operator
- A unique mechanical latch, integral to the operator boom engages automatically to make the door impossible to lever open
- Doors with windows and ventilation grilles, manually operated doors, or doors fitted between the opening are excluded from SBD certification
- Copies of SBD and test certification are available, if required, via the Hörmann UK Marketing Department



For further information on Secured by Design see our brochure.

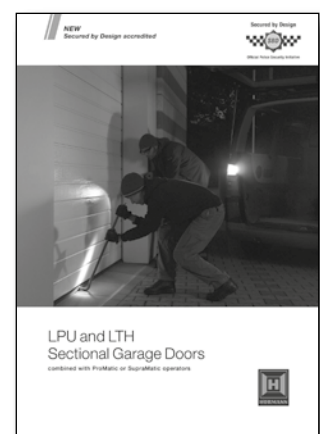



Hörmann Sectional Doors

LTE 40 – single-skinned doors with steel sections

Single doors with Z track tension springs giving low headroom as standard

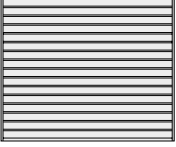

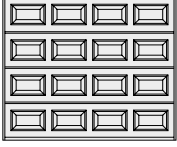
SINGLE DOORS								No. of panels
Door sizes BR		S-ribbed Woodgrain		M-ribbed Woodgrain		S-panelled Woodgrain		
Imperial	Metric	Outside White	Outside Colour	Outside White	Outside Colour	Outside White	Outside Colour	
6'10" x 6'2"	2080 x 1875	638	783	638	783	716	861	4
6'10" x 6'10"	2080 x 2080	667	828	667	828	740	901	4
7'0" x 6'6"	2134 x 2000	650	808	650	808	728	886	4
7'0" x 7'0"	2134 x 2125	667	835	667	835	740	908	4
7'6" x 6'6"	2286 x 2000	650	820	650	820	728	898	4
7'0" x 7'0"	2286 x 2125	667	847	667	847	740	920	4
7'4" x 7'4"	2286 x 2250	704	895	704	895	772	963	4
7'9" x 7'9"	2286 x 2375	812	1013	812	1013	889	1090	4
8'2" x 8'2"	2286 x 2500	811	1023	811	1023	887	1099	4
8'0" x 6'6"	2438 x 2000	676	857	676	857	754	935	4
7'0" x 7'0"	2438 x 2125	701	893	701	893	767	959	4
7'4" x 7'4"	2438 x 2250	737	940	737	940	802	1005	4
7'9" x 7'9"	2438 x 2375	845	1060	845	1060	915	1130	4
8'2" x 8'2"	2438 x 2500	844	1070	844	1070	914	1140	4
8'6" x 6'6"	2591 x 2000	676	868	676	868	754	946	4
7'0" x 7'0"	2591 x 2125	701	905	701	905	767	971	4
9'0" x 6'6"	2740 x 2000	762	965	762	965	874	1077	4
7'0" x 7'0"	2740 x 2125	785	1001	785	1001	890	1106	4
9'6" x 6'6"	2896 x 2000	787	1002	787	1002	918	1133	5
7'0" x 7'0"	2896 x 2125	817	1045	817	1045	933	1161	5
10'0" x 6'6"	3048 x 2000	787	1013	787	1013	918	1144	5
7'0" x 7'0"	3048 x 2125	817	1057	817	1057	933	1173	5

For information on outside colour, see page 17

Double doors with N track torsion springs (for low headroom see bottom of page 17)

DOUBLE DOORS			
Door sizes BR		S-ribbed Woodgrain	
Imperial	Metric	Outside White	Outside Colour
11'0" x 6'6"	3353 x 2000	1099	1348
7'0" x 7'0"	3353 x 2125	1139	1403
12'0" x 6'6"	3658 x 2000	1215	1486
7'0" x 7'0"	3658 x 2125	1266	1554
13'0" x 6'6"	3962 x 2000	1242	1536
7'0" x 7'0"	3962 x 2125	1291	1603
14'0" x 6'6"	4267 x 2000	1346	1662
7'0" x 7'0"	4267 x 2125	1417	1753
14'6" x 6'6"	4420 x 2000	1376	1704
7'0" x 7'0"	4420 x 2125	1449	1797
15'0" x 6'6"	4572 x 2000	1383	1722
7'0" x 7'0"	4572 x 2125	1455	1815
15'6" x 6'6"	4725 x 2000	1425	1775
7'0" x 7'0"	4725 x 2125	1497	1869
16'0" x 6'6"	4877 x 2000	1423	1784
7'0" x 7'0"	4877 x 2125	1497	1881

Prices Marked 2 – Not available ex-stock, delivery 4–8 weeks

Hörmann Sectional Doors

LPU 40 – double-skinned doors with steel sections – 42mm

Single doors with Z track tension springs giving low headroom as standard

//NEW Decograin surfaces
Winchester Oak and
Titan Metallic CH 703
Available from Autumn 2014

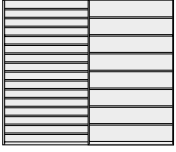
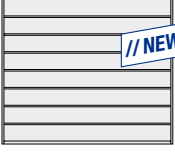
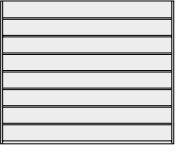
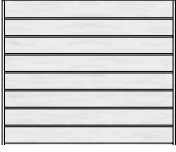

SINGLE DOORS									
Door sizes BR		S-ribbed Woodgrain/ M-ribbed Woodgrain		M-ribbed Sandgrain		M-ribbed Silkgrain / Micrograin		M-ribbed Decograin	
Imperial	Metric	Outside White	Outside Colour	Outside White	Anthracite grey Terra brown White aluminium	Outside White	Outside Colour	Rosewood, Golden Oak, Dark Oak, Winchester Oak, Night Oak	
6'10" x 6'2"	2080 x 1875	752	897	820	919	919	1064	1009	
6'6"	2080 x 2000	784	938	858	961	961	1115	1055	
6'10"	2080 x 2080	814	975	891	998	997	1158	1096	
7'0" x 6'6"	2134 x 2000	811	969	858	961	961	1119	1055	
7'0"	2134 x 2125	840	1008	891	998	997	1165	1096	
7'6" x 6'6"	2286 x 2000	811	981	858	961	961	1131	1055	
7'0"	2286 x 2125	840	1020	891	998	997	1177	1096	
7'4"	2286 x 2250	852	1043	934	1047	1046	1237	1150	
7'9"	2286 x 2375	917	1118	973	1090	1091	1292	1199	
8'2"	2286 x 2500	915	1127	1011	1133	1133	1345	1247	
8'0" x 6'6"	2438 x 2000	853	1034	905	1014	1016	1197	1119	
7'0"	2438 x 2125	885	1077	944	1058	1060	1252	1167	
7'4"	2438 x 2250	892	1095	975	1092	1093	1296	1203	
7'9"	2438 x 2375	960	1175	1018	1141	1143	1358	1258	
8'2"	2438 x 2500	957	1183	1062	1190	1194	1420	1316	
8'6" x 6'6"	2591 x 2000	853	1045	905	1014	1016	1208	1119	
7'0"	2591 x 2125	885	1089	944	1058	1060	1264	1167	
9'0" x 6'6"	2740 x 2000	923	1126	988	1107	1113	1316	1228	
7'0"	2740 x 2125	954	1170	1027	1151	1157	1373	1277	
9'6" x 6'6"	2896 x 2000	965	1180	1039	1164	1172	1387	1295	
7'0"	2896 x 2125	1001	1229	1080	1210	1218	1446	1347	
10'0" x 6'6"	3048 x 2000	931	1157	1039	1164	1172	1398	1295	
7'0"	3048 x 2125	964	1204	1080	1210	1218	1458	1347	

For information on outside colour, see page 17

Double doors with N track torsion springs (for low headroom see bottom of page 17)

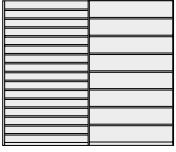
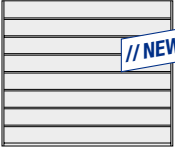
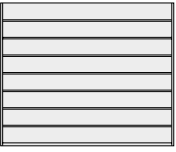
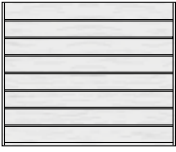
DOUBLE DOORS									
Door sizes BR		S-ribbed Woodgrain/ M-ribbed Woodgrain		M-ribbed Sandgrain		M-ribbed Silkgrain / Micrograin		M-ribbed Decograin	
Imperial	Metric	Outside White	Outside Colour	Outside White	Anthracite grey Terra brown White aluminium	Outside White	Outside Colour	Rosewood, Golden Oak, Dark Oak, Winchester Oak, Night Oak	
11'0" x 6'6"	3353 x 2000	1097	1346	1233	1381	1398	1647	1552	
7'0"	3353 x 2125	1140	1404	1280	1434	1453	1717	1612	
12'0" x 6'6"	3658 x 2000	1287	1558	1386	1553	1577	1848	1754	
7'0"	3658 x 2125	1335	1623	1440	1613	1639	1927	1823	
13'0" x 6'6"	3962 x 2000	1334	1628	1426	1598	1624	1918	1807	
7'0"	3962 x 2125	1384	1696	1479	1657	1685	1997	1876	
14'0" x 6'6"	4267 x 2000	1383	1699	1467	1644	1672	1988	1862	
7'0"	4267 x 2125	1437	1773	1526	1710	1739	2075	1937	
14'6" x 6'6"	4420 x 2000	1428	1756	1503	1684	1715	2043	1910	
7'0"	4420 x 2125	1486	1834	1565	1753	1785	2133	1988	
15'0" x 6'6"	4572 x 2000	1454	1793	1516	1698	1729	2068	1927	
7'0"	4572 x 2125	1511	1871	1578	1768	1801	2161	2007	
15'6" x 6'6"	4725 x 2000	1518	1868	1542	1728	1761	2111	1963	
7'0"	4725 x 2125	1576	1948	1604	1797	1831	2203	2041	
16'0" x 6'6"	4877 x 2000	1518	1879	1570	1759	1792	2153	1998	
7'0"	4877 x 2125	1576	1960	1631	1827	1863	2247	2077	

Intermediate sizes are available, please see your dealer for more details



Hörmann Sectional Doors

LPU 40 – double-skinned doors with steel sections – 42mm

Single doors with Z track tension springs giving low headroom as standard

// NEW Decograin surfaces
Winchester Oak and
Titan Metallic CH 703
Available from Autumn 2014

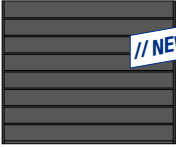
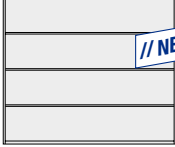

SINGLE DOORS		 M-ribbed Titan Metallic CH 703	 L-ribbed Sandgrain	 L-ribbed Silkgrain / Micrograin	 L-ribbed Decograin	Door sizes BR		Rosewood, Golden Oak, Dark Oak, Winchester Oak, Night Oak		
Imperial	Metric					Outside White	Anthracite grey Terra brown White aluminium		Outside White	Outside Colour
6'10" x 6'2"	2080 x 1875					1009	973		1090	1049
6'6"	2080 x 2000	1055	998	1118	1076	1230	1179			
6'10"	2080 x 2080	1096	1010	1132	1089	1250	1193			
7'0" x 6'6"	2134 x 2000	1055	998	1118	1076	1234	1179			
7'0"	2134 x 2125	1096	1010	1132	1089	1257	1193			
7'6" x 6'6"	2286 x 2000	1055	998	1118	1076	1246	1179			
7'0"	2286 x 2125	1096	1010	1132	1089	1269	1193			
7'4"	2286 x 2250	1150	1056	1183	1138	1329	1246			
7'9"	2286 x 2375	1199	1060	1188	1142	1343	1250			
8'2"	2286 x 2500	1247	1088	1219	1171	1383	1282			
8'0" x 6'6"	2438 x 2000	1119	1053	1180	1136	1317	1247			
7'0"	2438 x 2125	1167	1072	1201	1158	1350	1270			
7'4"	2438 x 2250	1203	1127	1263	1216	1419	1335			
7'9"	2438 x 2375	1258	1155	1294	1246	1461	1367			
8'2"	2438 x 2500	1316	1188	1331	1281	1507	1406			
8'6" x 6'6"	2591 x 2000	1119	1053	1180	1136	1328	1247			
7'0"	2591 x 2125	1167	1072	1201	1158	1362	1270			
9'0" x 6'6"	2740 x 2000	1228	1156	1295	1249	1452	1374			
7'0"	2740 x 2125	1277	1171	1312	1265	1481	1391			
9'6" x 6'6"	2896 x 2000	1295	1216	1362	1316	1531	1450			
7'0"	2896 x 2125	1347	1235	1384	1336	1564	1471			
10'0" x 6'6"	3048 x 2000	1295	1216	1362	1316	1542	1450			
7'0"	3048 x 2125	1347	1235	1384	1336	1576	1471			

For information on outside colour, see page 17

Double doors with N track torsion springs (for low headroom see bottom of page 17)

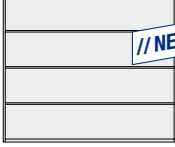
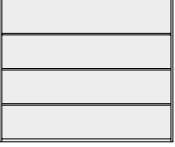
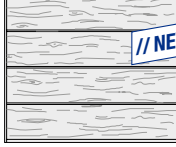
DOUBLE DOORS		 M-ribbed Titan Metallic CH 703	 L-ribbed Sandgrain	 L-ribbed Silkgrain / Micrograin	 L-ribbed Decograin	Door sizes BR		Rosewood, Golden Oak, Dark Oak, Winchester Oak, Night Oak		
Imperial	Metric					Outside White	Anthracite grey Terra brown White aluminium		Outside White	Outside Colour
11'0" x 6'6"	3353 x 2000					1552	1441		1614	1564
7'0"	3353 x 2125	1612	1463	1639	1588	1852	1754			
12'0" x 6'6"	3658 x 2000	1754	1624	1819	1766	2037	1956			
7'0"	3658 x 2125	1823	1653	1852	1798	2086	1991			
13'0" x 6'6"	3962 x 2000	1807	1675	1876	1823	2117	2020			
7'0"	3962 x 2125	1876	1699	1903	1848	2160	2047			
14'0" x 6'6"	4267 x 2000	1862	1725	1932	1878	2194	2081			
7'0"	4267 x 2125	1937	1753	1964	1908	2244	2115			
14'6" x 6'6"	4420 x 2000	1910	1773	1986	1930	2258	2140			
7'0"	4420 x 2125	1988	1800	2016	1960	2308	2173			
15'0" x 6'6"	4572 x 2000	1927	1791	2006	1951	2290	2163			
7'0"	4572 x 2125	2007	1819	2038	1982	2342	2198			
15'6" x 6'6"	4725 x 2000	1963	1824	2043	1987	2337	2204			
7'0"	4725 x 2125	2041	1855	2078	2020	2392	2241			
16'0" x 6'6"	4877 x 2000	1998	1855	2078	2022	2383	2243			
7'0"	4877 x 2125	2077	1888	2115	2058	2442	2283			

Intermediate sizes are available, please see your dealer for more details

Hörmann Sectional Doors

LPU 40 – double-skinned doors with steel sections – 42mm

Single doors with Z track tension springs giving low headroom as standard

//NEW Decograin surfaces
Winchester Oak and
Titan Metallic CH 703
Available from Autumn 2014

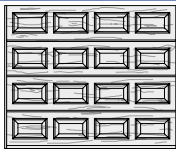
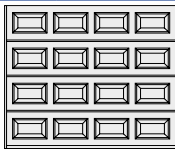

SINGLE DOORS		 L-ribbed Titan Metallic CH 703	 S-panelled Decograin	 S-panelled Woodgrain	No. of panels		No. of panels			
Door sizes BR					Rosewood, Golden Oak, Dark Oak, Winchester Oak, Night Oak	No. of panels	Outside White	Outside Colour	No. of panels	No. of panels
Imperial	Metric						Outside White	Outside Colour		
6'10" x 6'2"	2080 x 1875	1151	1234	4	944	1089	4			
6'6"	2080 x 2000	1179	1258	4	987	1141	4			
6'10"	2080 x 2080	1193		4	999	1160	4			
7'0" x 6'6"	2134 x 2000	1179	1258	4	1022	1180	4			
7'0"	2134 x 2125	1193	1272	4	1035	1203	4			
7'6" x 6'6"	2286 x 2000	1179	1258	4	1022	1192	4			
7'0"	2286 x 2125	1193	1272	4	1035	1215	4			
7'4"	2286 x 2250	1246	1389	4	1034	1225	4			
7'9"	2286 x 2375	1250	1420	4	1103	1304	4			
8'2"	2286 x 2500	1282	1471	4	1100	1312	4			
8'0" x 6'6"	2438 x 2000	1247	1335	4	1078	1259	4			
7'0"	2438 x 2125	1270	1353	4	1094	1286	4			
7'4"	2438 x 2250	1335	1528	4	1090	1293	4			
7'9"	2438 x 2375	1367	1548	4	1159	1374	4			
8'2"	2438 x 2500	1406	1577	4	1157	1383	4			
8'6" x 6'6"	2591 x 2000	1247	1335	4	1078	1270	4			
7'0"	2591 x 2125	1270	1353	4	1094	1298	4			
9'0" x 6'6"	2740 x 2000	1374	1464	4	1171	1374	4			
7'0"	2740 x 2125	1391	1489	4	1189	1405	4			
9'6" x 6'6"	2896 x 2000	1450	1545	5	1229	1444	5			
7'0"	2896 x 2125	1471	1572	5	1254	1482	5			
10'0" x 6'6"	3048 x 2000	1450	1545	5	1181	1407	5			
7'0"	3048 x 2125	1471	1572	5	1204	1444	5			

For information on outside colour, see below

All coloured doors are special order only – 4 to 8 weeks delivery. Please note: the prices listed as Outside Colour are for the following RAL colours only: RAL 1015, 3003, 5011, 5014, 6005, 6009, 7016, 7030, 7035, 7040, 8001, 8003, 8028, 9006 and 9007. Special RAL colours are available, please ask your garage door specialist.

Double doors with N track torsion springs (for low headroom see bottom of page)

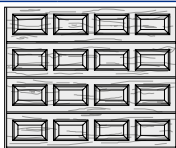
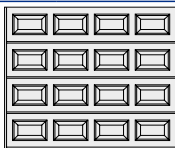
DOUBLE DOORS		 L-ribbed Titan Metallic CH 703	 S-panelled Decograin	 S-panelled Woodgrain	No. of panels		No. of panels			
Door sizes BR					Rosewood, Golden Oak, Dark Oak, Winchester Oak, Night Oak	No. of panels	Outside White	Outside Colour	No. of panels	No. of panels
Imperial	Metric						Outside White	Outside Colour		
11'0" x 6'6"	3353 x 2000	1729	1837	5	1407	1656	5			
7'0"	3353 x 2125	1754	1867	5	1433	1697	5			
12'0" x 6'6"	3658 x 2000	1956	2077	6	1659	1930	6			
7'0"	3658 x 2125	1991	2111	6	1687	1975	6			
13'0" x 6'6"	3962 x 2000	2020	2144	6	1725	2019	6			
7'0"	3962 x 2125	2047	2175	6	1749	2061	6			
14'0" x 6'6"	4267 x 2000	2081	2210	7	1793	2109	7			
7'0"	4267 x 2125	2115	2245	7	1822	2158	7			
14'6" x 6'6"	4420 x 2000	2140	2269	7	1859	2187	7			
7'0"	4420 x 2125	2173	2306	7	1889	2237	7			
15'0" x 6'6"	4572 x 2000	2163	2297	7	1892	2231	7			
7'0"	4572 x 2125	2198	2330	7	1924	2284	7			
15'6" x 6'6"	4725 x 2000	2204	2340	7	1985	2335	7			
7'0"	4725 x 2125	2241	2376	7	2016	2388	7			
16'0" x 6'6"	4877 x 2000	2243	2385	7	1985	2346	7			
7'0"	4877 x 2125	2283	2422	7	2016	2400	7			

Low headroom

Door with track application L, torsion spring at the back

Price

105

Intermediate sizes are available, please see your dealer for more details

Hörmann Sectional Doors

Optional extras and window designs



Colour surcharge			Price	
RAL to choose colours (please ask to see colour chart)			per m ² 51	
Door leaf in special colours (please ask to see colour chart)			per m ² 102	
Fittings				
Profile half cylinder 30 + 10mm, for garage door handle sets			each 33	
Handle sets				
Handle set, black plastic, prepared for profile cylinder			each 48	
Handle set, cast aluminium silver finish (F2), brass finish (F3), prepared for profile cylinder			each 123	
Handle set, cast aluminium RAL 9016, brown, brushed stainless steel, prepared for profile cylinder			each 139	
Handle set, polished stainless steel, prepared for profile cylinder			each 163	
Emergency release				
Emergency release for sectional doors with or without handle set (Please state at point of order)			each 33	
Special anchor set				
Set of 8 special anchors for between wall fitting			per set 39	
ThermoFrame set				
ThermoFrame set 1	Door height	up to 3000mm	(length 3210 mm)	per set 200
	Door width	up to 3250mm	(length 3250 mm)	
ThermoFrame set 2	Door height	up to 3000mm	(length 3210 mm)	per set 238
	Door width	from 3250mm up to 6000mm	(length 6000 mm)	
ThermoFrame set 3	For doors with track application H		(length 6000 mm)	per set 238
			(length 5500 mm)	

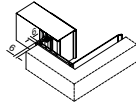
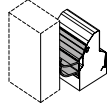

Set consists of

- Lintel seal (1x) with 2 lip seals
- Plastic angle profiles (2x) black, 84 x 22.5 mm with lip seal (frame covering may be required to match the colours)

Frame cover profiles matching the colour of the door – 55mm x 19.5mm and 90mm x 19.5mm: prices are per pair

Door heights	White RAL 9016						Colour						RAL to choose/CH 703				Decograin/Titan Metallic CH 703	
	Woodgrain		Sandgrain		Silkgrain		Woodgrain		Sandgrain		Silkgrain		Woodgrain		Silkgrain		55mm	90mm
	55mm	90mm	55mm	90mm	55mm	90mm	55mm	90mm	55mm	90mm	55mm	90mm	55mm	90mm				
2000mm	44	59	48	65	48	65	57	84	61	88	61	88	78	119	84	128	69	96
2125mm	47	62	51	69	51	69	60	89	65	93	65	93	82	127	89	135	73	102
2250mm	50	66	54	73	54	73	64	94	68	99	68	99	87	134	94	143	78	108
2375mm	52	69	57	77	57	77	67	99	72	104	72	104	92	141	99	151	82	114
2500mm	55	73	60	81	60	81	70	104	76	109	76	109	96	148	104	158	86	119

Silkgrain white/Titan Metallic CH 703 and Decograin colours are available ex-stock. **Please note colours and RAL to choose/CH 703 must be ordered with the door.**

Sandgrain is available in RAL 9016, 7016, 8028 and 9006

Renovation fascias

Set: Renovation fascias to cover damaged brickwork edges consisting of: 3 angle sections, 69/40mm, each 3000mm long

Price	126	138	138	163	175	175	189	189	143
-------	------------	------------	------------	------------	------------	------------	------------	------------	------------

Set: Fascia frame -95- consisting of: 2 fascias, 95mm, 2800mm long, 1 fascia 95mm, 3200mm long, fixing material

Price	144	156	156	181	193	193	195	207	160
-------	------------	------------	------------	------------	------------	------------	------------	------------	------------

Window designs for Sectional doors

LTE 40 with 3mm single pane in clear (FK) or crystal structure (KR), 3mm

LPU 40 with 16mm double pane in clear (DS) or crystal structure (DK)

	LPU 40	LTE 40
S0	75	69
S1	92	84
S2	92	84
S10	384	356
S20	480	445
S30	576	
S40	672	
S50	768	
S60	768	
M0	90	
L0	120	

Standard Colour Surcharges for the above windows. Please note: front window frame only is painted			Price
Standard colour or colour for Decograin	For glazing S0, S1 and S2 / M0 / L0	each	19
	For Sunrise glazing x No. of frames for width of door	each	25
RAL to choose	For glazing S0, S1 and S2 / M0 / L0	each	34
	For Sunrise glazing x No. of frames for width of door	each	45

Double-leaf insulated doors

with block frames, aluminium profiles





Special sizes for ribbed side doors, profile type 2



//NEW Decograin surfaces
Winchester Oak and
Titan Metallic CH 703
Available from Autumn 2014



Alignment of ribbing / sections is only possible with garage doors of the same height!

Ordering sizes Overall frame dimensions (RAM) Width x Height	 S-ribbed <i>Woodgrain</i>								
	Exterior White	Exterior Colour							
Fitting in the opening (opening outwards)									
From 1200 x 1960									
Up to 2500 x 2300	1886	2132							
Up to 2500 x 2558	1979	2225							

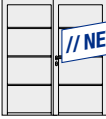
Ordering sizes Overall frame dimensions (RAM) Width x Height	 M-ribbed <i>Woodgrain</i>		 M-ribbed <i>Sandgrain</i>		 M-ribbed <i>Silkgrain</i>		 M-ribbed <i>Micrograin</i>		 M-ribbed <i>Decograin¹⁾</i>	
	Exterior White	Exterior Colour	Exterior White	Exterior Color²⁾	Exterior White	Exterior Color	Exterior White	Exterior Color	Exterior Timber design / Titan Metallic CH 703	
Fitting in the opening (opening outwards)										
From 1200 x 1960										
Up to 2500 x 2300	1886	2132	1958	2204	2018	2264	2018	2264	2205	
Up to 2500 x 2558	1979	2225	2055	2301	2118	2364	2118	2364	2316	

Ordering sizes Overall frame dimensions (RAM) Width x Height	 L-ribbed <i>Sandgrain</i>		 L-ribbed <i>Silkgrain</i>		 L-ribbed <i>Micrograin</i>		 L-ribbed <i>Decograin¹⁾</i>		Exterior Timber design / Titan Metallic CH 703	
	Exterior White	Exterior Color²⁾	Exterior White	Exterior Color	Exterior White	Exterior Color	Exterior White	Exterior Color		
Fitting in the opening (opening outwards)										
From 1200 x 1960										
Up to 2500 x 2300			2024	2270	2086	2332	2086	2332	2280	
Up to 2500 x 2558			2124	2370	2190	2436	2190	2436	2394	

- 1) *Decograin* surface with timber design film coating in Golden Oak, Dark Oak, Night Oak, Winchester Oak and Rosewood or decor film coating in Titan Metallic CH 703 (please state on order!)
- 2) Surface in *Sandgrain* only available in the colours RAL 7016 Anthracite grey, RAL 8028 Terra brown and RAL 9006 White aluminium. Other colours or RAL to choose are not possible!

RAL to choose (in accordance with the RAL colour chart) or colour CH 703	£
Frame inside and outside, infill outside	Surcharge on white version per door 376

RollMatic Roller Garage Door

Size range and prices Including operator

// NEW Decopaint surface
Available from July 2014



Doors are only available in priced size range listed! (Min. Production dimension 1000 x 1600mm) Note: Door size not over guide width



Exterior
White or Colour
(same price)

Clear height (LH) = ordering size	3100					1520	1653	1697	1751	1795	2063	2137	2227	2272					
	3000					1520	1653	1697	1751	1795	2063	2137	2227	2272					
	2875					1520	1653	1697	1751	1795	2063	2137	2227	2272					
	2750					1499	1584	1635	1698	1763	2002	2089	2165	2240					
	2675	1379	1379	1430	1430	1499	1584	1635	1698	1763	2002	2089	2165	2240					
	2625	1379	1379	1430	1430	1499	1584	1635	1698	1763	2002	2089	2165	2240					
	2500	1379	1379	1430	1430	1450	1537	1589	1649	1697	1807	2009	2049	2131	2221	2271	2320	2367	
	2375	1290	1290	1315	1315	1402	1512	1549	1583	1642	1747	1934	2011	2031	2146	2194	2244	2292	
	2250	1290	1290	1315	1315	1402	1512	1549	1583	1642	1747	1934	2011	2031	2146	2194	2244	2292	
	2125	1290	1290	1315	1315	1377	1466	1491	1533	1576	1660	1717	1944	1964	2086	2134	2184	2233	
2000	1290	1290	1315	1315	1328	1402	1451	1501	1523	1601	1653	1863	1910	1997	2044	2093	2143		
1800	1290	1290	1315	1315	1328	1402	1451	1501	1523	1601	1653	1863	1910	1997	2044	2093	2143		
1600	1290	1290	1315	1315	1328	1402	1451	1501	1523	1601	1653	1863	1910	1997	2044	2093	2143		
		1000	1250	1500	1750	1900	2000	2250	2500	2750	3000	3250	3500	3750	4000	4250	4500	4750	5000
		Clear width (LB) = ordering size																	

Manually operated version of the RollMatic roller garage door (not possible with external roller garage doors)	Price reduction	-154
External roller garage door	Surcharge	58
Additional fascia panel (Reinforcement of the fascia panel for fitting in the opening)		See page 22

Doors are only available in the priced size range listed! (Min. Production dimension 1000 x 1600mm) Note: Door size not over guide width



Exterior
Decopaint
Golden Oak
or Rosewood

Clear height (LH) = ordering size	3100					1635	1782	1840	1909	1967	2249	2338	2442	2501					
	3000					1631	1778	1836	1904	1961	2243	2331	2435	2494					
	2875					1627	1773	1830	1897	1955	2236	2323	2427	2485					
	2750					1601	1699	1762	1838	1916	2168	2267	2356	2443					
	2675	1441	1454	1517	1524	1598	1696	1759	1834	1912	2163	2262	2351	2438					
	2625	1440	1452	1515	1523	1597	1694	1756	1832	1909	2160	2259	2347	2434					
	2500	1438	1449	1512	1518	1543	1641	1705	1776	1836	1958	2171	2223	2316	2418	2479	2539	2598	
	2375	1346	1356	1392	1399	1490	1611	1659	1704	1774	1890	2088	2176	2207	2333	2392	2452	2511	
	2250	1343	1353	1388	1394	1486	1606	1653	1698	1767	1882	2080	2167	2197	2323	2382	2442	2500	
	2125	1340	1349	1384	1390	1456	1555	1590	1641	1694	1788	1855	2092	2122	2253	2311	2371	2430	
2000	1337	1346	1380	1386	1402	1486	1544	1603	1634	1722	1782	2002	2058	2155	2210	2269	2328		
1800	1333	1341	1374	1379	1395	1478	1535	1593	1623	1710	1770	1988	2043	2139	2194	2251	2309		
1600	1333	1341	1374	1379	1395	1478	1535	1593	1623	1710	1770	1988	2043	2139	2194	2251	2309		
		1000	1250	1500	1750	1900	2000	2250	2500	2750	3000	3250	3500	3750	4000	4250	4500	4750	5000
		Clear width (LB) = ordering size																	

Manually operated version of the RollMatic roller garage door (not possible with external roller garage doors)	Price reduction	-154
External roller garage door	Surcharge	58
Additional fascia panel (Reinforcement of the fascia panel for fitting in the opening)		See page 22

RollMatic Roller Garage Door

Size range and prices

Including operator



Doors are only available in the priced size range listed! (Min. Production dimension 1000 x 1600mm) Note: Door size not over guide width

 <p>Exterior Decograin</p> <p>Golden Oak or Rosewood</p>	Clear height (LH) = ordering size	3100					1975	2160	2246	2343	2429	2761	2880	3018	3105								
		3000					1965	2149	2234	2329	2414	2746	2864	2999	3086								
		2875					1954	2135	2219	2312	2396	2725	2841	2976	3061								
		2750					1918	2045	2135	2238	2343	2639	2768	2885	3000								
		2675					1682	1714	1802	1822	1912	2037	2126	2228	2331	2627	2756	2872	2987				
		2625					1678	1710	1798	1817	1906	2031	2120	2221	2324	2619	2748	2863	2978				
		2500					1671	1701	1788	1806	1840	1966	2053	2150	2234	2385	2638	2713	2832	2962	3048	3132	3214
		2375					1565	1594	1650	1668	1775	1925	1995	2061	2155	2300	2534	2648	2699	2854	2936	3020	3102
		2250					1557	1585	1640	1656	1763	1911	1980	2044	2137	2279	2512	2625	2674	2828	2908	2990	3071
		2125					1550	1576	1629	1644	1723	1847	1901	1972	2046	2164	2252	2528	2576	2736	2816	2896	2976
		2000					1542	1566	1618	1633	1657	1763	1841	1921	1969	2079	2161	2416	2491	2612	2688	2766	2845
		1800					1529	1552	1601	1614	1637	1741	1816	1894	1940	2047	2127	2379	2452	2570	2644	2721	2797
1600																							
					1000	1250	1500	1750	1900	2000	2250	2500	2750	3000	3250	3500	3750	4000	4250	4500	4750	5000	
					Clear width (LB) = ordering size																		

Manually operated version of the RollMatic roller garage door (not possible with external roller garage doors)

Price reduction

-154

External roller garage door not available with a Decograin surface!

Additional fascia panel

(Reinforcement of the fascia panel for fitting in the opening)

See page 22

Optional Extras

For RollMatic roller garage door including operator



Fitting compensation set (to accommodate for unevenness on the building structure, recommended when fitting behind/in front of the opening)	Article no.		£
Fitting compensation set LH ≤ 2300	8991235	Per set	30
Fitting compensation set LH > 2300	8991236	Per set	35
Chamfered bottom profile			
RollMatic roller garage door with chamfered bottom profile (not available in the surfaces Golden Oak and Rosewood)	In black	Per m	176
	in door colour	Per m	176
Additional fascia panel for fitting in the opening			
	In door colour	Per m	43

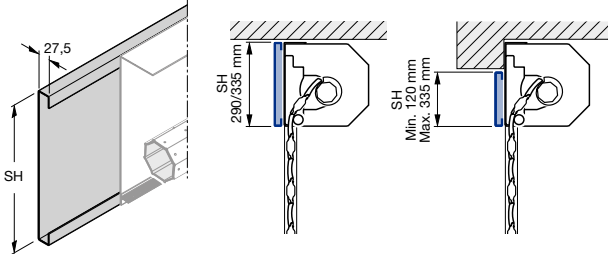

Reinforcement of the fascia panel

► State height (SH) and width!

For fitting in the opening, indicate the height (SH) 290 mm or 335 mm and total width = ordering size (clear width) +200 mm

Note:

State on door order, subsequent fitting is not possible.

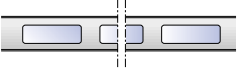
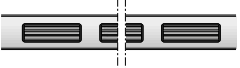
Optional extras for internal roller garage doors only			£
	Glazing element With clear synthetic pane, window cut-out 112 × 33 mm, black glazing frame on exterior, transparent on interior (maximum 10 sections per door, number of glazing elements depending on the door width) For side doors this is not possible in the bottom section and the lock area	Per m	19
	Ventilation grille Black plastic Ventilation cross section: approx. 13 cm ² /grille (maximum of 10 sections per door, number of ventilation grilles dependent on the door width) For side doors this is not possible in the bottom section and the lock area	Per m	19
Without barrel casing	(only possible from a clear height (LH) of 2500mm)	Price reduction	Per m -13

Accessories for RollMatic operators		Article no.	£
Motor connection line, 10 m		436523	29
Acoustic anti-lift kit		436524	Each 49
Emergency battery HNA 18		437727	Each 126
Emergency release			
Exterior emergency release for internal roller garage door		436526	Each 78
Exterior emergency release for external roller garage door	Exterior emergency release	436526	Each 78
	Accessory bag for double secured release	437728	Each 6
	Bowden cable, length 1 m, for double secured release SE	437986	Each 9

Note: All 3 articles are required for the external roller garage door!

Matching side door and accessories



Style 996

Ordering sizes Nominal size Width x Height	Style 996 White or Colour	Style 996 Decopaint Golden Oak or Rosewood	Style 996 Decograin Golden Oak or Rosewood
Size Range			
From 675 x 1750			
Up to 1000 x 2000	688	729	878
Up to 1250 x 2375	737	791	964

Lever handle sets for side doors

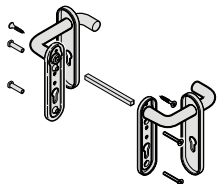

Standard: black plastic, prepared for profile cylinder	Each	1324002	39
Silver finish (F2) cast aluminium, prepared for profile cylinder	Each	1386100	134
Cast aluminium RAL 9016 (white), prepared for profile cylinder	Each	1386150	167
Cast aluminium RAL 8028 (brown), prepared for profile cylinder	Each	1386330	167
Brushed stainless steel, prepared for profile cylinder	Each	1386351	202
Polished stainless steel, prepared for profile cylinder	Each	1386350	202

Lever/knob handle set for side doors

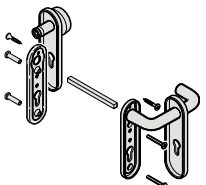

Standard: black plastic, prepared for profile cylinder	Each	1380000	89
Silver finish (F2) cast aluminium, prepared for profile cylinder	Each	1380100	164
Cast aluminium RAL 9016 (white), prepared for profile cylinder	Each	1380150	198
Cast aluminium RAL 8028 (brown), prepared for profile cylinder	Each	1380330	198
Brushed stainless steel, prepared for profile cylinder	Each	1380351	246
Polished stainless steel, prepared for profile cylinder	Each	1380350	246

Garage Door Operators

Operator Accessories



Garage door operators





Boom Length	SupraMatic E	SupraMatic P	SupraMatic HT	ProMatic	ProMatic Akku
K	471	503	For prices and specification see the 01-14 A Price List	374	634
M	488	519		391	651
L	578	610		481	741

The new hand transmitters, radio internal push buttons and code buttons with BiSecur technology are downwards compatible, i.e. they can also be used with series 1 and 2 operators (868 MHz).

- Possible
- Only in combination with a BiSecur radio receiver
- Only in conjunction with the BiSecur radio receiver ESE, status query possible
- Not available

Garage door operators





SupraMatic E / P	SupraMatic HT	ProMatic	ProMatic Akku	RollMatic
------------------	---------------	----------	---------------	-----------

Accessory	Description					
HS 1-button hand transmitter  black HS 1 BS Art. no. 436750 £ 52	High gloss plastic surface with chromed zinc die-cast caps <ul style="list-style-type: none"> • Impulse • Protection category: for dry rooms only • Temperature range: -20 °C to +60 °C • Battery: 1.5 V LR03 / AAA • Dimensions: 38 x 95 x 16 mm 	●	○	●	●	●
HS 4-button hand transmitter  black HS 4 BS Art. no. 436751 £ 54	High gloss plastic surface with chromed zinc die-cast caps <ul style="list-style-type: none"> • Impulse • Protection category: for dry rooms only • Temperature range: -20 °C to +60 °C • Battery: 1.5 V LR03 / AAA • Dimensions: 38 x 95 x 16 mm 	●	○	●	●	●
HS 5-button hand transmitter  black White HS 5 BS HS 5 BS Art. no. 436752 436753 £ 66 66	High gloss plastic surface with chromed zinc die-cast caps <ul style="list-style-type: none"> • Impulse • Status query (only for SupraMatic E / P and ProMatic) • Protection category: for dry rooms only • Temperature range: -20 °C to +60 °C • Battery: 1.5 V LR03 / AAA • Dimensions: 38 x 95 x 16 mm 	●	□	●	-	-
HS 5-button hand transmitter  black HS 5 BS Art. no. 436946 £ 66	Textured plastic surface with chrome-plated zinc diecast caps <ul style="list-style-type: none"> • Impulse • Status query (only for SupraMatic E / P and ProMatic) • Protection category: for dry rooms only • Temperature range: -20 °C to +60 °C • Battery: 1.5 V LR03 / AAA • Dimensions: 38 x 95 x 16 mm 	●	□	●	-	-

Garage Door Operators

Operator Accessories







		Garage door operators				
		SupraMatic E / P	SupraMatic HT	ProMatic	ProMatic Akku	RollMatic
<p>The new hand transmitters, radio internal push buttons and code buttons with BiSecur technology are downwards compatible, i.e. they can also be used with series 1 and 2 operators (868 MHz).</p> <ul style="list-style-type: none"> ● Possible ○ Only in combination with a BiSecur radio receiver – Not available 						
Accessory	Description					
<p>HSS 4-button security hand transmitter</p>  <p>Red HSS 4 BS</p> <p>Art. no. 436756 £ 92</p>	<p>High gloss plastic surface in red with chrome-plated zinc diecast caps</p> <ul style="list-style-type: none"> • Impulse • Additional function: Copy protection for hand transmitter coding (e.g. property management) • Protection category: for dry rooms only • Temperature range: -20 °C to +60 °C • Battery: 1.5 V LR03 / AAA • Dimensions: 38 × 95 × 16 mm <p>Note: Not downward compatible</p>	●	○	●	●	●
<p>Accessories For hand transmitters (HS and HSS)</p>  <p>Black White</p> <p>Hand transmitter station</p> <p>Art. no. 436691 436692 £ 7 7</p>	<ul style="list-style-type: none"> • For HS 1 BS, HS 4 BS, HS 5 BS, HSS 4 BS 					
<p>Accessories For hand transmitters (HS and HSS)</p>  <p>Hand transmitter holder Transparent, incl. visor clip</p> <p>Art. no. 436698 £ 6</p>	<ul style="list-style-type: none"> • For HS 1 BS, HS 4 BS, HS 5 BS, HSS 4 BS • For wall fitting or for fitting to the visor clip • Without fitting material 					
<p>HSE 1-button hand transmitter</p>  <p>// NEW</p> <p>Black HSE 1 BS</p> <p>Art. no. 436937 £ 52</p>	<p>High gloss plastic surface with chromed zinc die-cast caps</p> <ul style="list-style-type: none"> • Impulse • Incl. key ring for fixing to the key chain • Protection category: for dry rooms only • Temperature range: 0 °C to +60 °C • Battery: Lithium round cell 3 V / type CR 2032 • Dimensions: 28 × 70 × 14 mm 	●	○	●	●	●

Garage Door Operators

Operator Accessories









			Garage door operators				
			SupraMatic E / P	SupraMatic HT	ProMatic	ProMatic Akku	RollMatic
<p>The new hand transmitters, radio internal push buttons and code buttons with BiSecur technology are downwards compatible, i.e. they can also be used with series 1 and 2 operators (868 MHz).</p> <p>● Possible ○ Only in combination with a BiSecur radio receiver – Not available</p>							
Accessory			Description				
HSE	2-button hand transmitter		High gloss plastic surface with chromed zinc die-cast caps				
			<ul style="list-style-type: none"> • Impulse • Incl. key ring for fixing to the key chain • Protection category: for dry rooms only • Temperature range: 0 °C to +60 °C • Battery: Lithium round cell 3 V / type CR 2032 • Dimensions: 28 × 70 × 14 mm 				
	Black	White					
	HSE 2 BS	HSE 2 BS					
Art. no.	436754	436755					
£	52	52					
HSE	2-button hand transmitter HSE 2 BS						
Housing colour	Art. no.	£					
Violet	436869	73	●	○	●	●	●
Orange	436870	73					
Yellow	436871	73					
Red	436872	73					
Green	436873	73					
Carbon	436863	73					
Silver	436864	73					
Timber*, light	436867	73					
Rootwood*, light	436868	73					
Timber*, dark	436865	73					
Rootwood*, dark	436866	73					
HSE	2-button hand transmitter		Textured plastic surface with chrome-plated zinc diecast caps				
			<ul style="list-style-type: none"> • Impulse • Incl. key ring for fixing to the key chain • Protection category: for dry rooms only • Temperature range: 0 °C to +60 °C • Battery: Lithium round cell 3 V / type CR 2032 • Dimensions: 28 × 70 × 14 mm 				
	Black						
	HSE 2 BS						
Art. no.	437953						
£	52						
HSE	2-button hand transmitter		Textured plastic surface with plastic caps				
			<ul style="list-style-type: none"> • Impulse • Incl. key ring for fixing to the key chain • Protection category: for dry rooms only • Temperature range: 0 °C to +60 °C • Battery: Lithium round cell 3 V / type CR 2032 • Dimensions: 28 × 70 × 14 mm 				
	Black						
	HSE 2 BS						
Art. no.	436942						
£	47						
Accessories	For hand transmitter (HSE)		<ul style="list-style-type: none"> • For HSE 1 BS and HSE 2 BS • For wall fitting or for fitting to the visor clip • Without fitting material 				
							
	Hand transmitter holder incl. visor clip						
Art. no.	437006						
£	5						

Garage Door Operators

Operator Accessories







		Garage door operators				
		SupraMatic E/P	SupraMatic HT	ProMatic	ProMatic Akku	RollMatic
<p>The new hand transmitters, radio internal push buttons and code buttons with BiSecur technology are downwards compatible, i.e. they can also be used with series 1 and 2 operators (868 MHz).</p> <p>● Possible ○ Only in combination with a BiSecur radio receiver – Not available</p>						
Accessory		Description				
HSP	4-button hand transmitter	<ul style="list-style-type: none"> Impulse With sliding switch as a button lock-out Incl. key ring Temperature range: -20 °C to +60 °C Battery: Lithium round cell 3 V / type CR 2025 Dimensions (D x H): Ø48 x 13 mm 				
		●	○	●	●	●
	Black					
	HSP 4 BS					
Art. no.	436776					
£	60					
HSD	2-button hand transmitter	<ul style="list-style-type: none"> Impulse High-quality metal housing As a key ring Temperature range: -20 °C to +60 °C Battery: Lithium round cell 3 V / type CR 2025 Dimensions (W x H x D): 32 x 66 x 13 mm 				
	 	●	○	●	●	●
	Aluminium					
	HSD 2-A BS					
Art. no.	436774					
£	67					
	Chrome					
	HSD 2-C BS					
Art. no.	436775					
£	67					
HSZ	1-button hand transmitter	<ul style="list-style-type: none"> Impulse For insertion in a vehicle cigarette lighter Temperature range: -20 °C to +60 °C Battery: Lithium 3 V / type CR 2 Dimensions (D x H): Ø29 x 39 mm 				
	 	●	○	●	●	●
	Black					
	HSZ 1 BS					
Art. no.	436779					
£	50					
	Black					
	HSZ 2 BS					
Art. no.	436782					
£	50					
Batteries						
HNA	Emergency battery	<ul style="list-style-type: none"> Emergency power supply to bypass power failures up to 18 hours and max. 5 door cycles (depending on temperatures, situation of charge etc.) To be fixed on operator or garage ceiling Protection category: IP 20 Weight: approx. 2.3 kg Operating voltage: 24 V DC / 2.3 Ah Dimensions (W x H x D): 150 x 70 x 90 mm 				
		●	●	●	–	●
	HNA 18-3					
Art. no.	437726					
£	141					
	Suitable for series 2 ProMatic and SupraMatic operators.					
HNA	Emergency battery	<ul style="list-style-type: none"> Emergency power supply to bridge power outages Universal fixing for wall and floor fitting Double LED function display Protection category: IP 65 Weight: 3 kg Dimensions: 213 x 143 x 96 Battery voltage: 24 V DC / 2.3 Ah 				
		–	–	–	–	–
	HNA Outdoor					
Art. no.	436522					
£	148					
	For RotaMatic / P / PL from Autumn 2010 and for LineaMatic / P / H from year of manufacture 10 / 2009.					

Garage Door Operators

Operator Accessories





		Garage door operators				
		SupraMatic E / P	SupraMatic HT	ProMatic	ProMatic Akku	RollMatic
<p>The new hand transmitters, radio internal push buttons and code buttons with BiSecur technology are downwards compatible, i.e. they can also be used with series 1 and 2 operators (868 MHz).</p> <ul style="list-style-type: none"> ● Possible ○ Only in combination with a BiSecur radio receiver – Not available 						
Radio internal push button 868 MHz BiSecur, incl. battery (Range of radio signal depends on local conditions)						
FIT	Radio internal push button			<p>With 2 impulse buttons to control 2 operators via radio signal</p> <p>One additional button for On / Off function of connected command units</p> <p>Connection option for max. 2 control elements (volt-free contact) e.g. key switch</p> <p>Battery: 1.5 V LR03 / AAA</p> <p>Temperature range: 0 °C to +60 °C</p> <p>Protection category: IP 20, for dry rooms only</p> <p>Dimensions (W x H x D): 30 x 110 x 35 mm</p>		
Art. no.	FIT 2 BS	●	○	●	●	●
£	436757 54					
IT 3b	Internal push buttons			<p>With illuminated impulse button, additional buttons for light on / off and operator on / off</p> <p>With 7 m connecting lead, 2-wire</p> <p>Protection category: IP 20, for dry rooms only</p> <p>Dimensions (W x H x D): 80 x 110 x 30 mm</p>		
Art. no.	IT 3b	●	●	–	–	–
£	436204 35					
FCT 3 BS	Radio code switch			<p>Impulse, for control of up to 3 door operators</p> <p>Transmission of up to 3 radio codes, 868 MHz</p> <p>Power supply: Battery 4 x 1.5 V LR03 / AAA</p> <p>Illuminated keypad, clip frame</p> <p>Protection category: IP 54</p> <p>Temperature range: –20 °C to +60 °C</p> <p>Housing: Plastic</p> <p>Dimensions (W x H x D): 80 x 135 x 40 mm</p>		
Art. no.	FCT 3 BS	●	○	●	●	●
£	436758 89					
FCT 10 BS	Radio code switch			<p>Impulse, for control of up to 10 door operators</p> <p>Transmission of up to 10 radio codes, 868 MHz</p> <p>Power supply: Battery 4 x 1.5 V LR03 / AAA</p> <p>Illuminated keypad, sliding cover with metal embellishment</p> <p>Protection category: IP 54</p> <p>Temperature range: –20 °C to +60 °C</p> <p>Housing: Plastic</p> <p>Dimensions (W x H x D): 80 x 135 x 40 mm</p>		
Art. no.	FCT 10 BS	●	○	●	●	●
£	436759 146					
Radio finger-scan 868 MHz BiSecur (range of radio signal depends on local conditions!)						
FFL	Radio finger-scan			<ul style="list-style-type: none"> • Impulse, to control 2 operators using a fingerprint • Up to 12 fingerprints can be taught in, cannot be individually deleted • Setting / programming via 3 buttons • Housing: Plastic, sliding cover with metal embellishment • Display via 3 LEDs • Battery: 4 x 1.5 V LR03 / AAA • Protection category: IP 54 • Temperature range: –20 °C to +60 °C • Dimensions (W x H x D): 80 x 130 x 45 mm <p>Only for use with Hörmann BiSecur 868 MHz receivers.</p>		
Art. no.	FFL 12 BS	●	○	●	●	●
£	436788 208					

Operator Accessories

Lighting technology



				Garage door operators																																																									
				SupraMatic E / P	SupraMatic HT	ProMatic	ProMatic Akku	RollMatic																																																					
<p>The new hand transmitters, radio internal push buttons and code buttons with BiSecur technology are downwards compatible, i.e. they can also be used with series 1 and 2 operators (868 MHz).</p> <ul style="list-style-type: none"> ● Possible ○ Only in combination with a BiSecur radio receiver - Not available 																																																													
LED light strips – Variant overview																																																													
LED light strips can also be used for windows, doors or other applications independent of garage doors.																																																													
<p>LED light strip</p>  <p>Dimensions in mm (from – to)</p> <table border="1"> <thead> <tr> <th>Lintel fitting</th> <th>Door leaf fitting</th> <th>Art. no.</th> <th>£</th> </tr> </thead> <tbody> <tr><td>1000 – 1250*</td><td>1000 – 1250*</td><td>436550</td><td>115</td></tr> <tr><td>2000 – 2500</td><td>2000 – 2625</td><td>436551</td><td>173</td></tr> <tr><td>2625 – 3000</td><td>2750 – 3125</td><td>436552</td><td>246</td></tr> <tr><td>3125 – 3500</td><td>3250 – 3625</td><td>436553</td><td>270</td></tr> <tr><td>3625 – 4250</td><td>3750 – 4375</td><td>436554</td><td>303</td></tr> <tr><td>4375 – 4500</td><td>4500 – 4625</td><td>436555</td><td>365</td></tr> <tr><td>4625 – 4750</td><td>4750 – 4875</td><td>436556</td><td>378</td></tr> <tr><td>4875 – 5250</td><td>5000 – 5375</td><td>436557</td><td>400</td></tr> <tr><td>5375 – 6000</td><td>5500 – 6125</td><td>436558</td><td>435</td></tr> <tr><td>6125 – 6250</td><td>6250 – 6375</td><td>436559</td><td>496</td></tr> <tr><td>6375 – 6500</td><td>6500 – 6625</td><td>436560</td><td>508</td></tr> </tbody> </table>				Lintel fitting	Door leaf fitting	Art. no.	£	1000 – 1250*	1000 – 1250*	436550	115	2000 – 2500	2000 – 2625	436551	173	2625 – 3000	2750 – 3125	436552	246	3125 – 3500	3250 – 3625	436553	270	3625 – 4250	3750 – 4375	436554	303	4375 – 4500	4500 – 4625	436555	365	4625 – 4750	4750 – 4875	436556	378	4875 – 5250	5000 – 5375	436557	400	5375 – 6000	5500 – 6125	436558	435	6125 – 6250	6250 – 6375	436559	496	6375 – 6500	6500 – 6625	436560	508	<ul style="list-style-type: none"> • Light colour: neutral white • For fitting to the garage door leaf, below the garage lintel or at the side door • The LEDs are fitted on the light strip at a distance of 125 mm from each other and provide indirect lighting of the side door or garage door • Can be cut to size • Protection category: IP 65 • Can be optionally switched in conjunction with SupraMatic E, P, HT (HOR 1 or UAP 1 required, see page 23) <p>Note:</p> <ul style="list-style-type: none"> • Power supply unit (article no. 436534) is also required and must be ordered separately! • For fitting to the garage door leaf, the door leaf activating kit AT 3 (article no. 638296) is required! • For fitting to the lintel, a junction box (article no. 436535) is required! 					●	●	●	-	●
Lintel fitting	Door leaf fitting	Art. no.	£																																																										
1000 – 1250*	1000 – 1250*	436550	115																																																										
2000 – 2500	2000 – 2625	436551	173																																																										
2625 – 3000	2750 – 3125	436552	246																																																										
3125 – 3500	3250 – 3625	436553	270																																																										
3625 – 4250	3750 – 4375	436554	303																																																										
4375 – 4500	4500 – 4625	436555	365																																																										
4625 – 4750	4750 – 4875	436556	378																																																										
4875 – 5250	5000 – 5375	436557	400																																																										
5375 – 6000	5500 – 6125	436558	435																																																										
6125 – 6250	6250 – 6375	436559	496																																																										
6375 – 6500	6500 – 6625	436560	508																																																										
<p>Accessories</p> <p>For LED light strip (not shown)</p> <p>Power supply unit</p> <p>Art. no. 436534</p> <p>£ 37</p>				<ul style="list-style-type: none"> • Required to supply the LED light strip on the lintel or door leaf with power • 230 V AC / 6 V DC / 12 W 																																																									
<p>For LED light strip</p> <p>Art. no.</p> <p>Activating kit for door leaf AT 3 638296</p> <p>Junction box 436535</p>																																																													
LED reflector lamp																																																													
<p>LED reflector lamp</p>  <p>Art. no. 436992</p> <p>£ 15</p>				<ul style="list-style-type: none"> • 3 watts • 110° angle of reflected beam • Light colour: Warm white • Energy efficiency class A++ 					●	-	-	-	-																																																

Garage Door Operators

Operator Accessories



The new hand transmitters, radio internal push buttons and code buttons with BiSecur technology are downwards compatible, i.e. they can also be used with series 1 and 2 operators (868 MHz).

- Possible
- Only in combination with a BiSecur radio receiver
- Only in conjunction with the BiSecur radio receiver ESE, status query possible
- Not available

Garage door operators

SupraMatic E / P	SupraMatic HT	ProMatic	ProMatic Akku	RollMatic
------------------	---------------	----------	---------------	-----------

BiSecur LAN / WLAN Gateway



BiSecur Gateway

Art. no. 4511701
£ 233

- Central interface for controlling operators by smartphone or tablet
- Protection category: IP 20
- Power supply: 100–240 V AC
- Secondary voltage: 5 V DC / 1.0 A
- Housing: White plastic (RAL 9003)
- Temperature range: –20 °C to +60 °C
- Dimensions (B × H × T):
135 × 30 × 32 mm
154 × 30 × 32 mm (with fastening eyelets)
- Scope of delivery:
Network cable CAT 5 E, 1 m
Power supply unit 100–240 V AC
Cable from USB-A to DC

●	□	●	-	-
---	---	---	---	---

Note:

An automatic door system may only be controlled without visual contact to the door if a photocell has been installed on the door in addition to the standard power limit.

BiSecur Gateway

The central interface for operators and radio receivers enables operation by an administrator and 10 other users. In total, up to 16 functions can be carried out by each user.

The connection to the router in the home network is established via network cable (LAN version) or wirelessly (WLAN version). The strength of the WLAN signal can be tested via an LED on the gateway, in order to find the most suitable location for operation.

System prerequisites:

Android devices

- From software version 2.3
- Min. 256 MB RAM
- Adobe® AIR™ from version 4.0

iOS devices

- From software version iOS 6
- From iPod touch, 4th generation
- From iPhone 4
- From iPad 2
- From iPad mini

Home network

- Broadband Internet access
- Internet browser
 - Firefox from version 14
 - Chrome from version 22
 - Safari from version 4
 - Internet Explorer from version 10
 - Other current web browsers that support JavaScript and CSS 3
- WLAN router
 - WLAN standard IEEE 802.11 b/g/n
 - WPA-PSK or WPA2-PSK encryption
- Available LAN socket on router
- Power supply (110–240 V AC / 50 / 60 Hz)
- Smartphone or tablet with access to the App StoreSM or to GoogleTM play
- Location with remote connection to the device to be operated

Hörmann Portal BiSecur Home

The smartphone and the gateway must be registered via the Hörmann Portal for worldwide control via the Internet. A one-time registration is done via a certified Hörmann Internet site and ensures the highest data security.

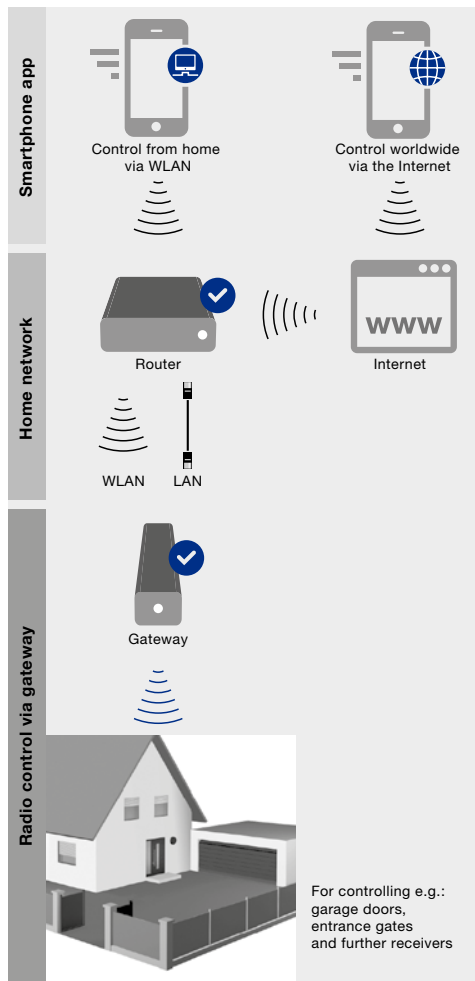

Warranty

Hörmann products are manufactured to the highest quality standards and leave our factory only after rigorous quality testing. However, if you should have grounds for complaint, this section tells you what our door warranty offers, and how to go about making your claim.

In the unlikely event of a warranty claim becoming necessary, please contact the dealer or distributor who originally supplied your garage door. Your dealer should then supply details of the claim, together with a copy of the warranty card provided with the door and proof of purchase to the Product Services Department at Hörmann (UK) Ltd. To enable your claim under warranty to be processed as quickly as possible, you should provide the following details:

1. Your name, address and telephone number
2. Original invoice with date of purchase
3. Product description/door type and product number
4. Description of defect

An assessment of the claim will then be made. This may require Hörmann to inspect the product in-situ. In the event that there is no legitimate warranty claim under the terms specified herein, you may be liable for the costs of the inspection visit. We strongly recommend that you take note of the care and usage instructions displayed on the stickers on the back of your garage door, and on the page opposite, and that you follow these instructions throughout.

Hörmann installers

Hörmann (UK) Ltd has a nationwide network of recommended installers who will be able to offer you a regular maintenance service on your garage door. Please call us on 01530 513050 for details of your nearest dealer.

Hörmann (UK) Ltd Garage Door Warranty

Warranty Period	The purchaser is granted a warranty covering the safe and reliable function of the Hörmann garage door for a period of 10 years from the date of purchase. A 5 year warranty applies to springs, wire cables, track rollers, hinges and guide rollers. The warranty period for replacement parts is 6 months or to the end of the current warranty period, whichever is longer. In the case of foil-coated timber-effect, a warranty of 5 years is granted, for timber and GRP doors a warranty of 2 years is granted on the door panels alone under the terms and conditions specified herein. The door mechanism and steel frame (if applicable) is covered by the 10 year warranty period.
Requirements	Warranty claims are only applicable in the country where the garage door was purchased. The product must have been purchased through our authorised distribution channels. The warranty only covers damage to the contract object. The fully completed warranty card together with the receipt of purchase correspondingly dated substantiates your right to claim under the warranty.
Performance	During the warranty period we undertake to rectify any and all defects to the Hörmann product which can be proved to be attributed to a material or manufacturing fault. We pledge at our discretion either to exchange the defective merchandise for faultless merchandise, repair it or allow a reduction in price. We do not accept costs for dismantling and installation nor for carriage. Replaced parts become our property. The warranty does not cover damage caused through: <ul style="list-style-type: none"> • normal wear and tear • improper installation • negligent care and maintenance • improper initial and subsequent operation • negligent or wanton destruction • external influences such as fire, water, salts, alkaline solutions, acids, abnormal environmental influences • mechanical damage through improper transport and fitting • priming and other surface protection treatments • incorrect or too late applied surface protection treatments • repair by non-qualified persons • using non-Hörmann parts without the approval of the manufacturer • removal of the product number or making it unidentifiable

Electric Operator Warranty

A separate 5 year warranty is granted on our electric operators. This includes operator mechanics, motor and motor control systems. A 2 year warranty is granted on radio equipment, accessories and system controls. There is no warranty on consumables (e.g. fuses, batteries, bulbs etc.). For further details please contact us on 01530 513030 or through our website on www.hormann.co.uk

User Information/Care

Finish – Steel Doors

The coating process applied to the door and chassis is environmentally friendly. Minor scratches or marks are not covered under the conditions of our warranty and should be repaired immediately to prevent corrosion and deterioration of the panel. Corrosive substances such as acids, alkalines, and salts, etc. should be cleaned from the door immediately; failure to do so will result in deterioration of the finish, which will not be covered under our warranty. Should deterioration of the finish start to occur you will need to repaint your door immediately. Prepare the surface lightly with wet and dry. Then treat with solvent based 2 pack epoxy wash primer and a normal commercial paint (cellulose paint must not be used). Hörmann steel doors are a finished product. They do not require re-painting on site. They are however not immune to damage, which can occur at any stage of the handling of the product from factory to site.

Finish – Timber Doors

Timber panels are coated with a neutralising base-stain. Doors must be stored upright, under cover, with wrapping intact, until wrapping is removed. As soon as the door is unwrapped, one coat of a good quality basecoat primer must be applied to both sides of the door. Immediately after installation, your timber doors require a further two coats of a good quality exterior wood finish on both sides. Initial application and periodic treatment should be carried out strictly in accordance with the woodstain manufacturer's instructions. Failure to follow these instructions will result in early deterioration of the timber panel.

Finish – GRP Doors

GRP door panels should periodically be washed down using water. This should be done more frequently if fitted near the sea. Bird droppings will bleach the finish on GRP and should be removed using water as soon as possible. GRP doors should not be painted over.

Paint Finish – Steel Doors

Minor surface damage can easily be repaired using touch up sprays or sticks without invalidating warranties.

Extracts from DHF consumer advice



The following document was designed by the Association of Garage Door Specialists, updated by the DHF and endorsed by all major UK garage door manufacturers, as a guide for purchasers of domestic garage doors.

Visual appearance of Garage Doors

A new garage door can be a significant investment that will transform the appearance of your home. This information is a guide to the quality you can expect.

The Quality Check

The quality check should be carried out in natural daylight, not direct sunlight. Stand at a distance of 3 metres from the door to view the overall appearance. The door is acceptable if, taking into account the facts below, none of the following are readily visible on the face of the door:

- Marks or distortion associated with the manufacturing process
- Minor indentations, marks or scuffs on the surface
- Paint or stain blemishes

The Facts

Steel Doors

Panel Distortion The rolling or pressing of steel panels during manufacture will cause distortion in the steel and while every effort is made to keep this to a minimum, inevitably some visible distortion will remain. The application of high gloss paints will make this slight distortion more apparent, especially under certain lighting conditions, such as car headlamps, or bright sunshine.

Paint Finish Primed doors – the primer coating is applied as a base coat only and as such requires additional finishing with a good quality exterior paint. Any marks or scratches on the primer coat should be rubbed down and repainted as part of this finishing process.

Timber Doors Finished doors – the factory application of the paint finish is an automated process and this may result in minor blemishes or slight inconsistencies in the paint, particularly in the area of panel joints.

Timber

Timber is a natural product and there will be variations in pattern, colour, shading and grains. No two doors will be the same, because wood naturally expands and contracts according to environmental conditions, joints will open and close and some minor curvature may occur.

It is vital that timber doors are fully finished as per the manufacturers instructions before exposure to the elements.

GRP and Composite Plastic Doors

Mould Marks GRP doors are individually handcrafted in a mould and are then hand finished. Some minor marks and blemishes will inevitably remain after this process.

Translucency When viewed from the inside, it is often possible to see variations in the translucency of the door, particularly around and between areas of relief. Such variations do not detract from the overall strength or build quality of the door.

All Doors

Colour Match Pairs of doors should be ordered together to obtain the best colour match, bearing in mind the limitations of the materials used in the construction. Timber garage doors cannot be ordered as matching sets.

Size Variation As the size of a door changes in height and/or width, the panel frequency and profile can change, therefore doors of the same style but of different sizes can be significantly different in appearance.

Clearances All doors require operating clearances, i.e. the gap between the door panel and the frame opening, these are inbuilt during manufacture and should not be reduced by means of infills, or draughtproofing.

Deflection When in the open position, all doors will display a level of vertical deflection or “sag” across the width of the panel. Individual manufacturers' specifications should be consulted for exact tolerances.

Power Operated Garage Doors

It is against the law to install a power operated garage door in the UK without complying with the Machinery Directive.

To comply with the Machinery Directive both the door and the operator used in the installation must have a Declaration of Incorporation from the manufacturer.

On completion of the installation the installer must provide a Declaration of Conformity and apply a CE mark giving details of the installation to the door/operator combination, which is now classed as a machine.

The installer must issue to the customer a Declaration of Conformity on completion of the installation.

The installer must hold copies of both the Declaration of Incorporation and the Declaration of Conformity on a technical file for inspection by the relevant authorities.

If any of the above requirements are not fulfilled the installation is illegal.

Please ensure for your own safety and peace of mind that whoever installs your electric operator is both willing and able to fulfil these requirements; if they are not – do not use them!

Members of the DHF Garage Door Installer Group can and will install your Hörmann operator safely and legally.

Since the company's policy is one of continuous improvement of its products, we reserve the right to make any alterations in design, manufacture or price. All business is governed by the company's Standard Conditions and this document does not form any part of any contract with the company and statements contained in it should not be construed as representations or warranties.